

Name: **Catalogue 7**

Year: **2023**

Company: **Civic s.r.l.**

PRODUTTORI

MANUFACTURERS

VENDITORI SEL

CONSULENTI C

**WE ARE CIVIC**

MULTILANGUA

PROFESSIONIST

PROFESSIONAL

ERS ARTIGIANI

LLERS

CONSULTANTS

MULTILINGUA

AGE

TI

LS

# 20 YEARS OF EXPERIENCE

## ANNI DI ESPERIENZA

*La luce è stata il passato,  
è il presente e  
sarà il nostro futuro.*

**PROGETTIAMO OGGI LE SOLUZIONI PER IL DOMANI.**

*Light was the past,  
it is the present and  
it will be our future.*

**TODAY WE DESIGN THE SOLUTIONS FOR TOMORROW.**

# Index

## Indice

Su di noi   About us	.6
<b>Nuovi prodotti   New products</b>	<b>.14</b>
Indice prodotti   Products Index	.18
Legenda   Legend	.24
<b>OUTDOOR</b>	
.28	Esterni soffitto e parete Exterior wall & ceiling
.56	Esterni profili e incassi Exterior surface and recessed profiles
.92	Paletti e proiettori Poles & projectors
.118	Esterni incasso a pavimento Exterior Buried & uplights
<b>INDOOR</b>	
.150	Sistemi lineari Lighting systems
.202	Faretti Spotlights
.224	Downlights
.242	Luci d'ambiente Ambient lights
Accessories	.244

# ILLUMINAZIONE DA 29 ANNI

LIGHTING FROM  
29 YEARS





La produzione degli apparecchi d'illuminazione avviene negli stabilimenti di Trezzano Sul Naviglio (Milano) dove si trova anche il centro logistico per la spedizione degli ordini in Italia e all'estero.

Il controllo di qualità viene eseguito su ogni singolo pezzo che viene testato e collaudato prima di lasciare la sede.

CIVIC, avvalendosi di un sistema produttivo strutturato e controllato, conferma la propria attenzione verso la qualità dei prodotti.

La progettazione ad opera di un reparto interno dedicato, la scelta di fornitori leader nel loro settore e la cura nella realizzazione del prodotto da parte di personale specializzato, contribuiscono alla realizzazione di apparecchi di qualità destinati a durare nel tempo.

## Qualità

The production of the lighting fittings takes place in the factory of Trezzano Sul Naviglio (Milan) where there is also the logistics centre for the shipment of orders in Italy and abroad.

The quality control, done on every single piece, that is tested and controlled before leaving the premises.

CIVIC makes use of a structured and controlled production system and this confirms its focus quality.

The design done by a dedicated internal department, the choice of leading suppliers in their sector and the care in the production by specialized personnel, contribute to the creation of quality lighting fittings designed to last over time.

**Made in Italy**



# 100% FORNITORI ITALIANI

Civic può vantare una produzione interamente italiana nei propri stabilimenti di Trezzano S/N (Milano).

Le materie prime ed i componenti scelti dal nostro ufficio tecnico sono esclusivamente di alta qualità, totalmente Made in Italy.

Questo permette a CIVIC di avere sempre un dialogo diretto con i propri fornitori ed essere al passo con le ultime novità di ogni settore.

Civic can boast an entirely Italian production in its factories in Trezzano S/N (Milan).

The raw materials and components chosen by the technical department are exclusively of high quality and totally Made in Italy.

This allows CIVIC to always have a direct dialogue with its suppliers and be in step with the latest innovations in each sector.





Showroom - Trezzano sul Naviglio, MI

---

# MILANO

## ITALY

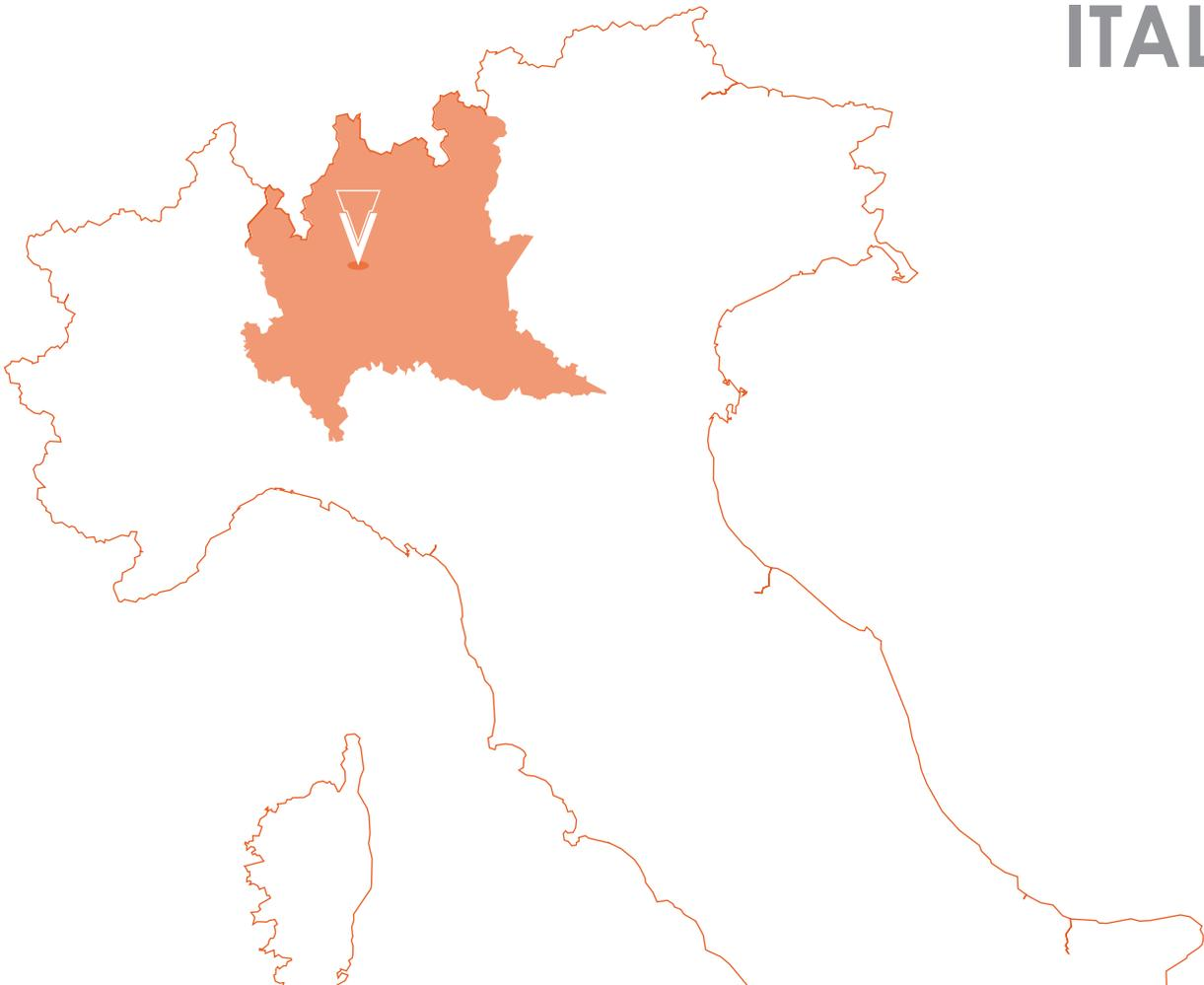



## Mario Abbate

Siciliano DOC ma cresciuto a Milano, il Sig. Salvatore Mario Abbate o meglio "il Geometra Abbate", come amavano chiamarlo i suoi collaboratori ed amici, fondò la società CIVIC S.r.l. nel 1994.

Fortemente convinto nell'importanza del servizio al cliente, il Geometra Abbate fu un imprenditore lungimirante dal punto di vista tecnico ed estetico: fu il primo in Italia a creare i sistemi lineari dalle forme più svariate.

Capace di comprendere le esigenze del mercato creò due sistemi in auge ancora oggi: il ROTONDO e L'OVALE, tra i modelli ancora più copiati al mondo.

Sicilian DOC but raised in Milan, Mr. Salvatore Mario Abbate or better "Il Geometra Abbate", as his collaborators and friends loved to call him, founded the company CIVIC S.r.l. in 1994.

Strongly convinced in the importance of the service to his customers, "il Geometra Abbate" was a forward-looking entrepreneur from the technical and aesthetic point of view: he was the first in Italy to create linear systems with different shapes.

Able to understand the needs of the market, he created two systems still in vogue today: the ROUND and OVAL, among the most copied models in the world.

---

# DALLA TRADIZIONE FROM TRADITION





# ALL'INNOVAZIONE TO INNOVATION

La capacità di seguire l'andamento del mercato e le mutevoli esigenze dei consumatori, ha permesso a CIVIC di adattarsi senza alcuna difficoltà all'arrivo delle nuove sorgenti luminose a LED. Dapprima modelli già esistenti vennero adattati al nuovo modo di illuminare e successivamente l'ufficio tecnico, arricchitosi intanto di professionisti sempre all'avanguardia, ha saputo creare nuovi modelli nati con e per le sorgenti a LED.

Il costante impegno anche dei figli in azienda ha permesso a CIVIC di sapersi sempre rinnovare e di restare al passo con i tempi, diventato quello che è oggi ovvero una realtà in grado di produrre apparecchi d'illuminazione tecnica e di design per esterni ed interni sempre al passo con i tempi.

The ability to follow the trend of the market and the changing needs of the consumers, have allowed CIVIC to adapt without any difficulty to the arrival of new LED light sources. At first, existing models were redesigned to the new way of lighting and then the technical office, enriched in the meantime with specialised professionals, has been able to create new models born with and for the LED sources.

The constant commitment also of the sons in the company, has given CIVIC the capability to always renew itself and keep up with the times becoming the reality that it is today: capable to produce technical and design lighting fittings for outdoor and indoor always original and fashionable.



# LIMIT

Siamo orgogliosi di produrre in Italia e di poter esportare la bellezza e la qualità del Made in Italy nel mondo.

L'anno che si è concluso, ha visto le nostre esportazioni raggiungere svariati luoghi del globo, arrivando ad oltre 28 diversi paesi.

We are proud to produce in Italy and to be able to export the beauty and quality of Made in Italy around the world.

The last year has seen our exports reach various places around the globe, reaching over 28 different countries.

**Everywhere  
you need**

# Custom products made with you

Una delle chiavi del successo di CIVIC è stata la capacità e la voglia di accontentare sempre i propri clienti creando così soluzioni in grado di adattarsi agli scenari più diversi. Negli anni, CIVIC è stata definita come la società del "Tailor Made" per la sua capacità quasi di cucire, sulle esigenze del cliente, apparecchi d'illuminazione adatti ai suoi progetti.

Custom Made per CIVIC significa: colori, lunghezze, potenze, temperature di colore ed altre caratteristiche realizzate su richiesta, perché per CIVIC il cliente è sempre al primo posto.

One of the keys to the success of CIVIC has been the ability and desire to always satisfy its customers creating solutions that can adapt to the most diverse scenarios. Over the years, CIVIC has been often called as the company of the "Tailor Made" for its ability almost to sew, on the needs of the customer, lighting fixtures suitable for his projects.

Custom Made for CIVIC means: colours, lengths, powers, colour temperatures and other features made on request, because for CIVIC the customer is always in first place.

# TRIPLES

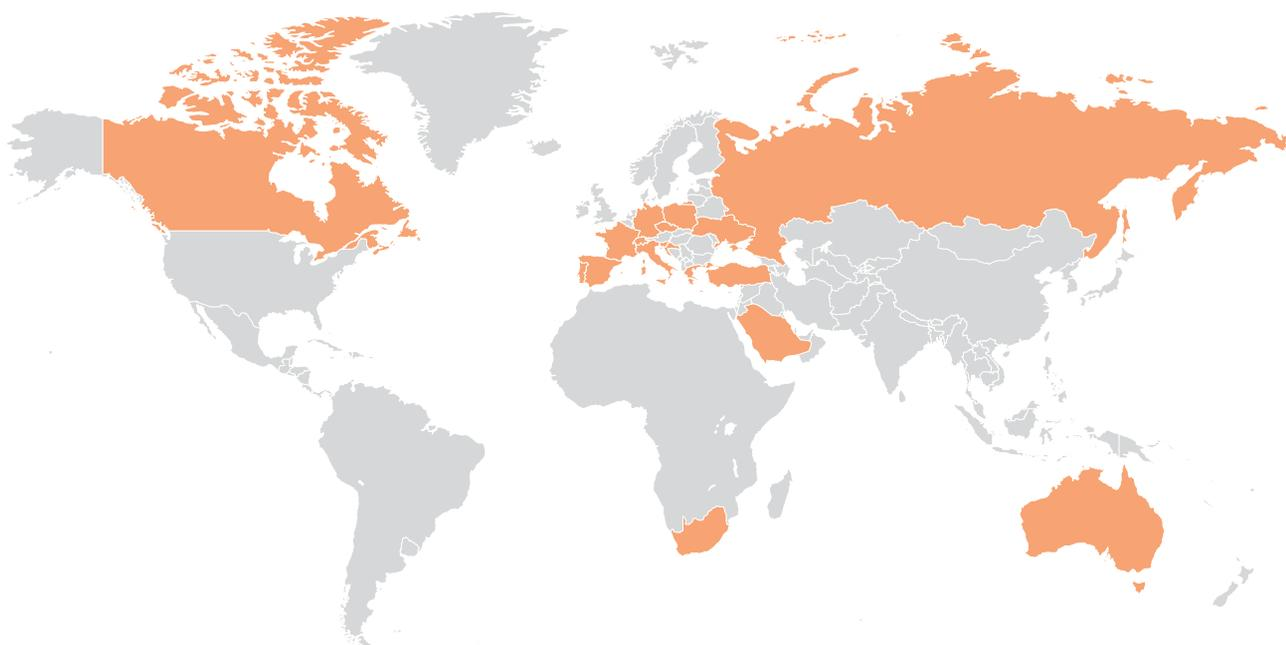

from  
**INSIDE**

Minu Square

Pag 152



Minu Lap

Pag 152



Cocktail UGR

Pag 176

T-Uni UGR

Pag 182



**NEW**

NEW



Mini Orfeo Pro  
Pag 94



Tebe  
Pag 110



Raggio Up  
Pag 142



Ios  
Pag 46



Net 50  
Pag 48

Raggio Spot  
Pag 106



to  
OUTSIDE

Indice

PRODOTTI

PRODUCTS

Index



# ESTERNI

## VERSO L'OUTDOOR TO OUTDOOR

Le mutate esigenze sociali che accomunano tutti noi hanno reso gli spazi esterni particolarmente importanti e graditi. Per questo motivo CIVIC ha deciso di sfruttare la sua esperienza nel settore dell'outdoor per migliorare i modelli esistenti e creare nuove forme per l'illuminazione di facciate, giardini, viali e tutti gli spazi esterni dove le esigenze illuminotecniche si sposano con il design e l'innovazione.

The changing social needs that we all have in common have made outdoor spaces particularly important and appreciated. This is the reason why CIVIC has decided to take advantage of its experience in the outdoor sector to improve the existing models and create new forms for facade lighting, gardens, avenues and all outdoor areas where lighting needs are combined with design and innovation.



### SOFFITTO E PARETE CEILING AND WALL



— APOLLO — 30



— MINI APOLLO — 30

APOLLO  
SERIES



— MINI ORFEO — 36



— LUXA — 40



— los — 46



— SOLE — 50



— CARD — 50

SEGNAPASSO  
SERIES

# OUTDOOR

# ESTERNI

## PROFILI PROFILES



— ALU PROOF 58

NET  
SERIES



— NET 16 64



— NET 50 64



— NET 70 64

CABRIO  
SERIES



— CABRIO 72



— CABRIO RECESSED 72



— RAISE 82



— SPIDER RECESSED 86

## PALETTI & PROIETTORI POLES & PROJECTORS



— MINI ORFEO 94  
PRO



— NIK 98



— TITAN 102



NEW

RAGGIO SPOT 106



NEW

TEBE 110



MINI APOLLO PALETTO 114

## INCASSI A PAVIMENTO BURIED & UPLIGHTS



ZEUS 120



PERSEO 120



ERA 120



DIANA 120



ZANTE 130



ERIC 130



DAVID 130



BOSS 138



RAGGIO SIDE 142



NEW

RAGGIO UP 142

CARRABILI  
DRIVEABLE SERIES

CALPESTABILI  
WALKABLE SERIES

RAGGIO  
SERIES

# OUTDOOR

# INTERNI

## SISTEMI LINEARI LIGHTING SYSTEMS



MINU  
SERIES



MINU  
DIFFUSER 152



MINU-R 152



MINU  
SQUARE 152



MINU  
LAP 152



ULISSE 164



ROUND 168



SHADOW 172

COCKTAIL  
SERIES



COCKTAIL  
DIFFUSER 176



COCKTAIL  
UGR 176



T-UNI 182



T-UNI  
LENS 182



T-UNI  
UGR 182

T-UNI  
SERIES



T-UNI  
RECESSED 182



T-UNI RECESSED  
FRAMELESS 182

T3  
SERIES



T-3 196



T-3 RECESSED  
FRAMELESS 196



## FARETTI SPOTLIGHTS



— **DIVA IN** 204



— **DIVA PLUS** 204



— **DIVA BASE** 204



— **BINARI TRACKS** 212  
**230V**



— **DONNA** 214  
**SMALL & LARGE**



— **DONNA** 214  
**INFINITY**



— **BINARI TRACKS** 222  
**48V**

DIVA  
SERIES

DONNA  
SERIES



## DOWNLIGHTS



— **FLUX** 226



— **MODO** 230



— **AIR** 238



## LUCI D'AMBIENTE AMBIENT LIGHTS



— **F 44** 244



— **F 55** 244

# INDOOR

# ACCESSORI

## PROFILI PER STRIP LED TAPELIGHT PROFILES

---



**ZERO** **252**  
**SURFACE**



**BASE 1** **253**



**BASE 3** **254**



**GRADO** **255**

## DRIVERS

---



**256**

# ACCESSORIES

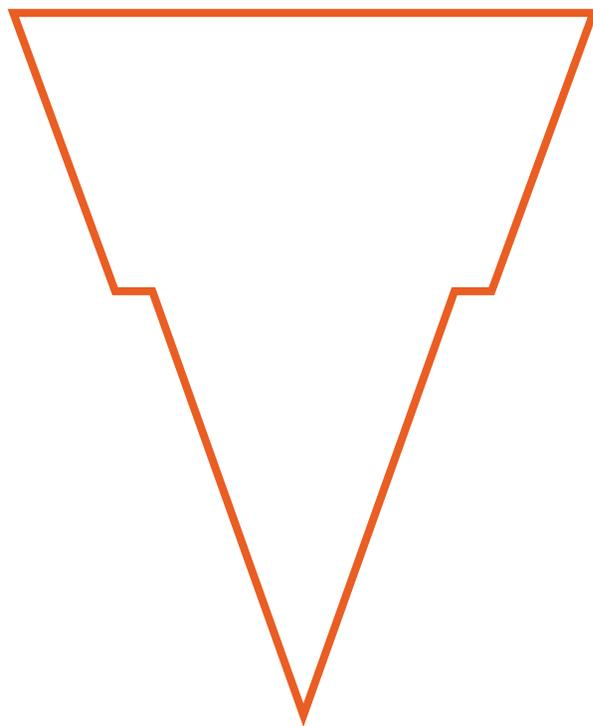

CE	IP65
LED	RG1
CRI 80	Driver incl.
L80 B10	50000H
	Mac Adam 3



NOME PRODOTTO  
PRODUCT NAME

**CABRIO**

Z.  
COLOR

- anodizzato/anodised -05
- antracite/anthracite -06
- grigio chiaro opaco/clear matt grey -37
- custom -99

COLORE  
COLOUR

DISEGNO TECNICO  
TECHNICAL DRAWING

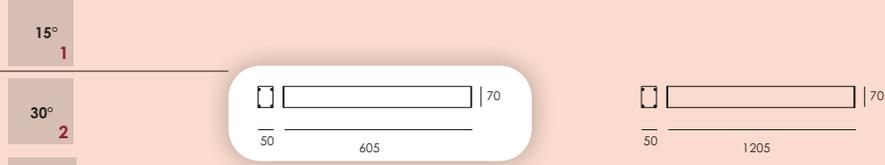

AGGIUNTE AL  
CODICE BASE  
ADD TO BASE CODE

- 15° **1**
- 30° **2**
- 10x45° **3**
- CRI80 **5**
- Y. **4000K** **7**
- 3000K **8**
- DIM. 1-10V **A1**
- DALI **A2**

CODICE BASE  
BASE CODE

CODICE / CODE	L.MM	W	LM	FASCIO / BEAM	PREZZO / PRICE
JEC.5916.0 5 Y. Z	605	12.5W/230V LED	1585/1502	diffuso/diffuse 120°	€ 251,00
JEC.5921.1 5 Y. Z	605	14x1.2W/230V LED	1502/1295	stretto/narrow 15°	€ 313,10
JEC.5921.2 5 Y. Z	605	14x1.2W/230V LED	1502/1295	largo/wide 30°	€ 313,10
JEC.5921.3 5 Y. Z	605	14x1.2W/230V LED	1502/1295	ellittico/elliptical 10x45°	€ 313,10
JEC.5921.4 5 Y. Z	605	14x1.2W/230V LED	1502/1295	ellittico/elliptical 11x30°	€ 313,10
JEC.5918.0 5 Y. Z	1205	25W/230V LED	3170/3004	diffuso/diffuse 120°	€ 353,50
JEC.5923.1 5 Y. Z	1205	28x1.2W/230V LED	3016/2590	stretto/narrow 15°	€ 442,00
JEC.5923.2 5 Y. Z	1205	28x1.2W/230V LED	3016/2590	largo/wide 30°	€ 442,00
JEC.5923.3 5 Y. Z	1205	28x1.2W/230V LED	3016/2590	ellittico/elliptical 10x45°	€ 442,00
JEC.5923.4 5 Y. Z	1205	28x1.2W/230V LED	3016/2590	ellittico/elliptical 11x30°	€ 442,00

ACCESSORI / ACCESSORIES

	JEC.AP Attacchi a parete (coppia). Wall mount (pair).	€ 20,00		AAA.CN3 Connettore IP68, 3vie. IP68 waterproof connector, 3way.	€ 31,40
	JEC.APR Ganci di fissaggio regolabili (coppia). Fixing adjustable hook (pair).	€ 30,00		AAA.CN4 Connettore IP68, 4vie. IP68 waterproof connector, 4way.	€ 31,40

COMPOSIZIONE DEL CODICE COMPLETO

Identifica il codice base e poi scegli D, X, Y, Z, A.

COMPOSE THE CODE FORMAT

Identify base code and choose D, X, Y, Z, A.

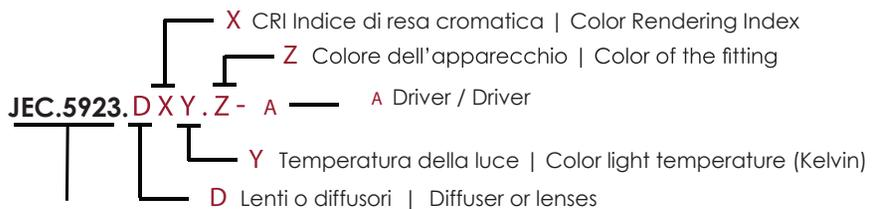

Codice base che identifica la famiglia del prodotto e le varie sottocategorie  
Base code identifies the family product and lengths

ESEMPIO | EXAMPLE

Famiglia Family	Corpo Body	Lenti Diffusori Diffuser Lenses	CRI	Kelvin	Colour	Driver
JEC	5923	3	5	7	.05	A2
Cabrio	L.1205mm	10x45°	CRI80	4000K	Anodizzato Anodized	DALI Driver



# LEGENDA

Simbolo	Descrizione	Description
	Marchatura CE contraddistingue la conformità del prodotto ai requisiti di sicurezza previsti per l'immissione sul mercato dell'unione europea.	CE Mark It distinguishes the product conformity to the safety requirements that are necessary for the introduction of the product on the european market.
	Classe 1 Apparecchio che necessita di messa a terra. Sono ad essa collegate tutte le parti che potrebbero essere toccate e in caso di difetto causare una scossa elettrica.	Class 1 Luminaire that needs earth connection. To the earth are connected all the parts that might be touched and in case of defect cause electrical shock.
	Classe 2 Apparecchio che necessita di messa a terra. Tutte le parti metalliche che potrebbero causare una scossa elettrica in caso di difetto non possono essere toccate.	Class 2 Luminaire that doesn't need earth connection. All the metal parts that might cause electrical shock in case of defect cannot be touched.
	Classe 3 Apparecchio per uso a bassa tensione (non superiore a 24V) con alimentazione mediante trasformatore di sicurezza.	Class 3 Luminaire for low voltage use (not exceeding 24V) supplied with a safety transformer.
IP	Grado di protezione dell'apparecchio contro l'ingresso di solidi e liquidi: la prima cifra identifica il grado di protezione contro l'ingresso di corpi solidi, la seconda quello contro l'ingresso di liquidi.	Protection degree of the fitting against the penetration of solids and liquids: the first number identifies the protection degree against the entry of solid bodies, the second one the protection degree against the entry of liquid.
IP1X	IP1X - Protetto contro la penetrazione di corpi solidi di dimensioni superiori a 50 mm. IP2X - Protetto contro la penetrazione di corpi solidi di dimensioni superiori a 12 mm. IP3X - Protetto contro la penetrazione di corpi solidi di dimensioni superiori a 2,5 mm. IP4X - Protetto contro la penetrazione di corpi solidi di dimensioni superiori a 1 mm. IP5X - Protetto contro la penetrazione della polvere. IP6X - Protetto completamente contro la penetrazione della polvere.	IP1X - Protected against the entry of solid bodies with dimensions of more than 50 mm. IP2X - Protected against the entry of solid bodies with dimensions of more than 12 mm. IP3X - Protected against the entry of solid bodies with dimensions of more than 2,5 mm. IP4X - Protected against the entry of solid bodies with dimensions of more than 1 mm. IP5X - Protected against entry of dust. IP6X - Completely protected against entry of dust.
IPX1	IPX1 - Protetto contro le cadute verticali di gocce d'acqua.  IPX2 - Protetto contro le cadute dell'acqua con inclinazione fino a 15°. IPX3 - Protetto contro la pioggia. IPX4 - Protetto contro gli spruzzi. IPX5 - Protetto contro i getti d'acqua. IPX6 - Protetto contro le ondate. IPX7 - Protetto all'immersione temporanea. IPX8 - Protetto contro alla sommersione prolungata.	IPX1 - Protected against the vertical falling of water drops.  IPX2 - Protected against the falling of water with maximum inclination of 15°. IPX3 - Protected against rain. IPX4 - Protected against sprinklings. IPX5 - Protected against water jets. IPX6 - Protected against waves. IPX7 - Protected against temporary immersion. IPX8 - Protected against prolonged immersion.
	Angolo di basculamento.	Adjustment angle.
	Angolo di rotazione.	Rotation angle.
	Distanza minima dall'oggetto illuminato.	Minimum distance from the enlightened object.
Codice	Colore	Color
 02	bianco RAL9010	white RAL9010
 03	nero RAL9010	black RAL9010
 05	anodizzato naturale	natural anodized
 06	grigio antracite	anthracite grey
 28	grigio chiaro RAL7035	clear grey RAL7035
 32	bianco raggrizzante	rough white
 33	nero raggrizzante	rough black
 37	grigio chiaro opaco	clear matte grey
 39	corten	corten
 50	grigio metallizzato	metallic grey
 99	colore su richiesta	custom color

OUTDOOR ESTERNI  
ESTERNI Outdoor  
OUTDOOR OR ESTER  
ESTERNI OUTDOO  
ESTERNI **OUTDO**  
OUTDOOR OR ESTER  
ESTERNI Outdoor  
ESTERNI OUTDOO  
OUTDOOR OR ESTER

NI OUTDOOR ES  
or ESTERNI Outd  
RNI OUTDOOR  
OR ESTERNI OU  
**OR Outdoor** ES  
RNI ESTERNI OU  
or OUTDOOR  
OR Outdoor ES  
RNI ESTERNI OU

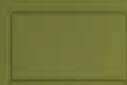

# A SOFFITTO E PARETE

## Exterior wall & ceiling



ETE

Outdoor

# A P O L L O



Scopri anche / Look at  
**Mini Apollo paletto**  
pag. 114  
Paletti e proiettori  
Poles and bollards



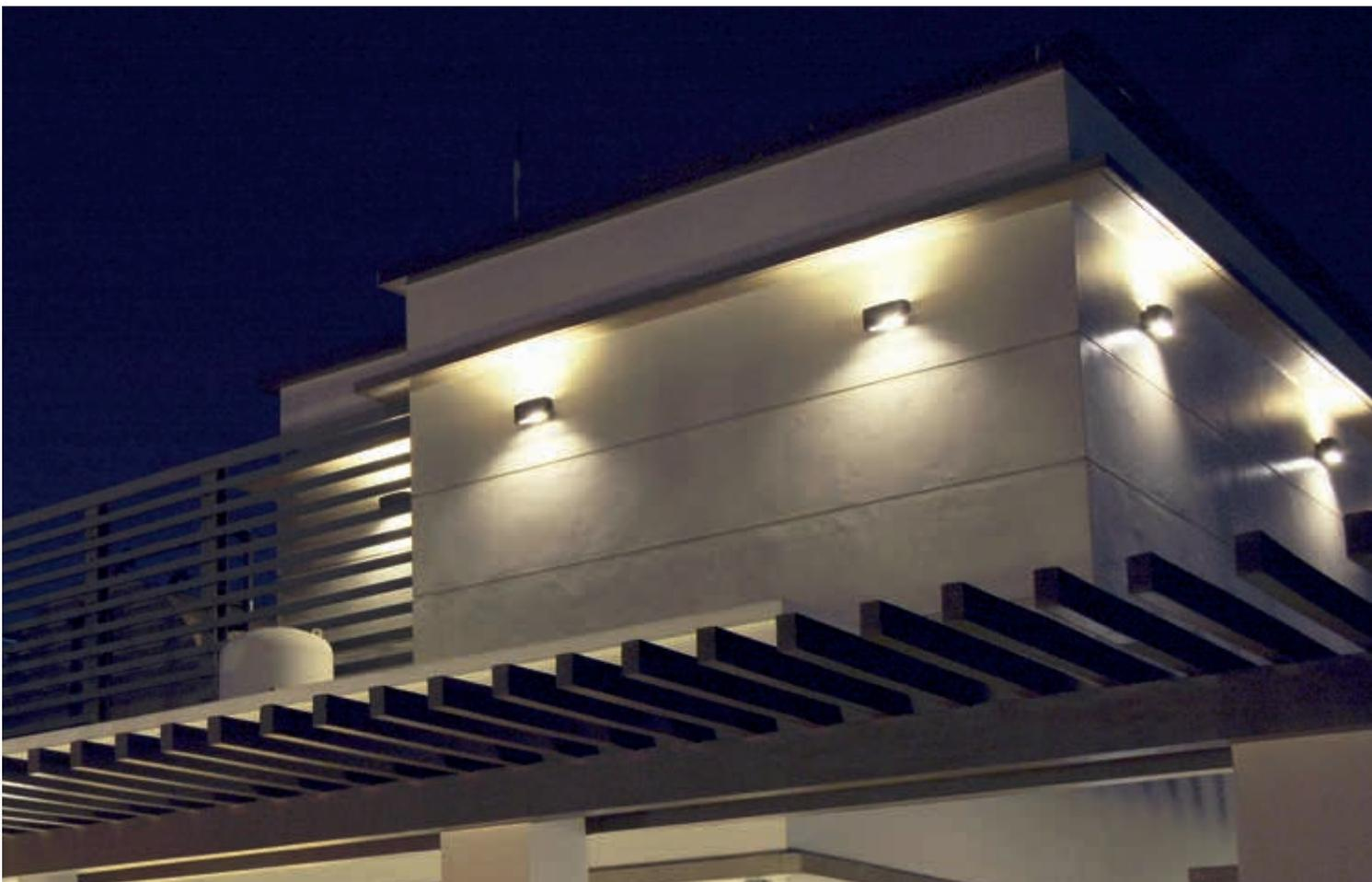



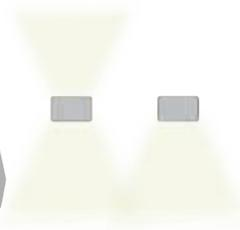

## APOLLO

La struttura è in fusione di alluminio verniciato a polveri epossipoliestere. Vetro temperato trasparente/sabbiato. LED: tono luce bianco 4000K o 3000K, emissione diretta e diretta/indiretta, simmetrica o asimmetrica.

Potenze a partire da 3000lm luce diretta asimmetrica, fino a 5400lm luce diretta/indiretta.

The structure is in die cast aluminum powder coated. LED: 4000K or 3000K white light tone, emission direct and direct/indirect, symmetric or asymmetric.

Powers from 3000lm, with direct light asymmetrical, up to 5400lm with direct/indirect light.

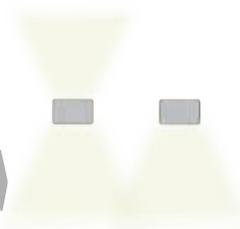

## MINI APOLLO

La struttura è in fusione di alluminio verniciato a polveri epossipoliestere. Vetro temperato trasparente/sabbiato. LED: tono luce bianco 4000K o 3000K, emissione diretta e diretta/indiretta, con lenti a fascio stretto e largo, con riflettore a fascio largo o luce diffusa. Potenze a partire da 4,8W/456lm luce diretta fino a 9,6W/1008lm luce diretta/indiretta.

The structure is in die cast aluminum powder coated. LED: 4000K or 3000K white light tone, emission direct and direct/indirect, with narrow or wide beam lenses, wide beam reflector or diffuse beam.

Powers from 4,8W/456lm with direct light, up to 9,6W/1008lm direct/indirect light.

CE	IP65
CRI 80/90	RG1
LED	Driver on/off incl.
L80 B10	50000H
⏚	Mac Adam 3

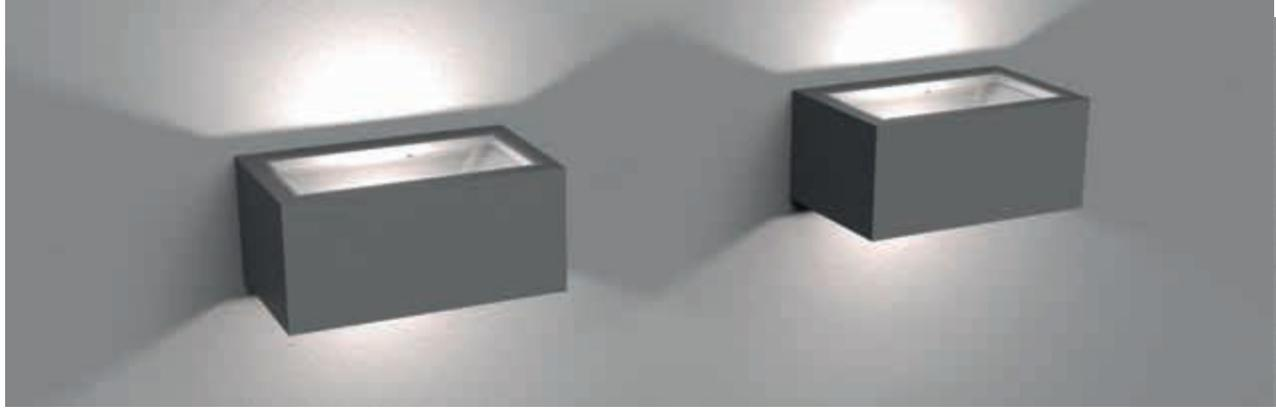

# A P O L L O

Z. COLOR

- antracite/anthracite -06
- bianco ragg./rough white -32
- nero ragg. / rough black -33
- grigio chiaro/clear grey -37
- custom -99

D. TRASPARENTE CLEAR 0

SABBIATO SANDED 1

X. CR180 5

CR190 6

Y. 4000K 7

3000K 8

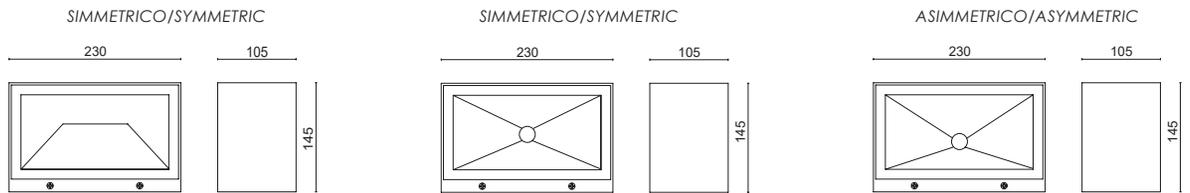

COD. ON/OFF	W	LM	EMISSIONE / EMISSION
SIMMETRICO/ SYMMETRIC			
<b>MTA.5410. D X Y. Z</b>	12.5W/230V LED	1780/1700	diretta/direct
<b>MTA.5411. D X Y. Z</b>	25W/230V LED	3560/3400	diretta+indiretta/direct+indirect
SIMMETRICO/ SYMMETRIC			
<b>MTA.5408. 0 X Y. Z</b>	17W/230V LED	2700/2550	diretta/direct
<b>MTA.5409. 0 X Y. Z</b>	34W/230V LED	5400/5100	diretta+indiretta/direct+indirect
ASIMMETRICO/ ASYMMETRIC			
<b>MTA.5404. 1 X Y. Z</b>	26.3W/230V LED	3000/3000	diretta/direct

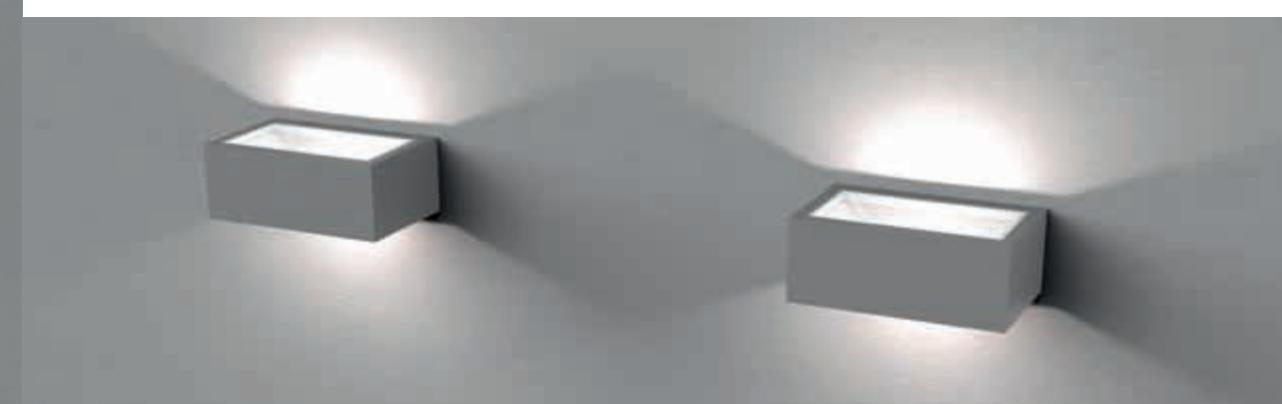

CE	IP65
CRI 80/90	RG1
LED	Driver on/off incl.
L80 B10	Mac Adam 3
50000H	⏚

- 06- antracite/anthracite
- 32- bianco ragg./rough white
- 33- nero ragg. / rough black
- 37- grigio chiaro/clear grey
- 99- custom

**Z.**  
COLOR

# MINI APOLLO

## MINI APOLLO LENTI/LENSES

SIMMETRICO/SYMMETRIC

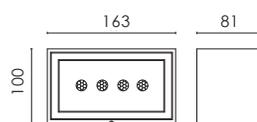

## MINI APOLLO RIFLETTORE/REFLECTOR

SIMMETRICO/SYMMETRIC

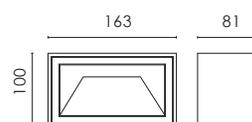

**D.**  
LARGO  
LARGE  
60°  
1

**STRETTO  
NARROW  
15°  
3**

**STRETTO  
NARROW  
+  
LARGO  
LARGE  
4**

**X.**  
CRI80  
5

**CRI90  
6**

**Y.**  
4000K  
7

**3000K  
8**

COD. ON/OFF

W

LM

EMISSIONE / EMISSION

LENTI/LENSES

COD. ON/OFF	W	LM	EMISSIONE / EMISSION
MTA.5416. <b>D X Y. Z</b>	4.8W/230V LED	504/456	diretta/direct
MTA.5417. <b>D X Y. Z</b>	9.6W/230V LED	1008/912	diretta+indiretta/direct+indirect

RIFLETTORE/REFLECTOR

MTA.5416. <b>2 X Y. Z</b>	9,6W/230V LED	850/800	diretta/direct
MTA.5417. <b>2 X Y. Z</b>	9,6W/230V LED	850/800	diretta+indiretta/direct+indirect

# MINI ORFEO

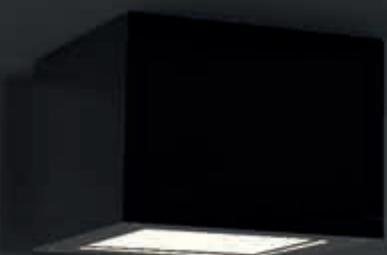

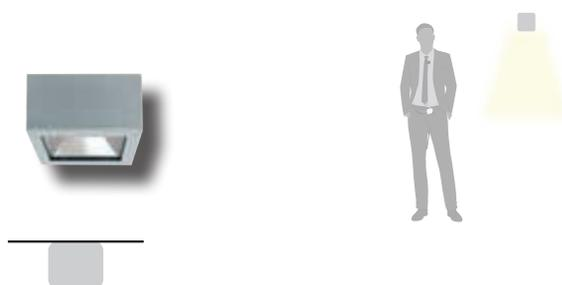

## MINI ORFEO

Faretto da soffitto realizzato in alluminio pressofuso e diffusore in vetro temperato trasparente o satinato. Disponibile in diversi colori. Dimensioni: 155x155 mm.

The body is made of die-cast aluminum and tempered transparent or satined glass diffuser and it is available in different colors. Dimensions : 155x155mm.

Scopri anche / look at:

**Mini Orfeo Pro**

pag. 94

Paletti & proiettori

Poles & bollards



CE	IP65
LED	RG1
CRI 80/90	Driver on/off incl.
L80 B10	50000H
⚡	Mac Adam 3



# MINI ORFEO

**Z.**  
COLOR

- antracite/anthracite -06
- bianco ragg./rough white -32
- nero ragg. / rough black -33
- grigio chiaro/clear grey -37
- custom -99

**X.**  
CRI80  
5

CRI90  
6

**Y.**  
4000K  
7

3000K  
8

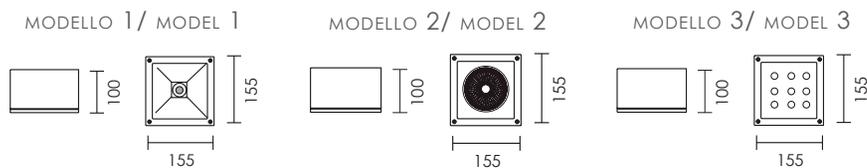

COD. ON/OFF	W	LM	FASCIO / BEAM	DIFFUSORE/ DIFFUSER
MODELLO 1/ MODEL 1				
<b>MTP.5411. 0 X Y. Z</b>	12,5W/230V LED	2650/2540	60°	trasparente/transparent
<b>MTP.5411. 1 X Y. Z</b>	12,5W/230V LED	2650/2540	60°	satinato/satined
MODELLO 2/ MODEL 2				
<b>MTP.5433. 1 X Y. Z</b>	12,5W/230V LED	2650/2540	13°	trasparente/transparent
<b>MTP.5433. 2 X Y. Z</b>	12,5W/230V LED	2650/2540	20°	trasparente/transparent
<b>MTP.5433. 3 X Y. Z</b>	12,5W/230V LED	2650/2540	38°	trasparente/transparent
MODELLO 3/ MODEL 3				
<b>MTP.5444. 1 X Y. Z</b>	18W/230V LED	1880/1750	15°	trasparente/transparent
<b>MTP.5444. 2 X Y. Z</b>	18W/230V LED	1880/1750	25°	trasparente/transparent
<b>MTP.5444. 3 X Y. Z</b>	18W/230V LED	1880/1750	38°	trasparente/transparent

## ACCESSORI / ACCESSORIES



**MTP.AG**  
Schermo antiabbagliamento.  
Anti-glare screen.







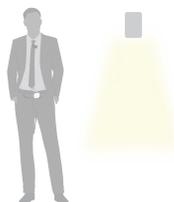

## LUXA

Serie di apparecchi per esterni. Disponibile nelle versioni a parete e a soffitto. Struttura in estruso di alluminio e viterie in acciaio inox. Driver incluso.

Series of outdoor lighting fittings. Available as wall or ceiling version. Structure in aluminum. Stainless steel screws. Driver included.



## MINI LUXA

Serie di apparecchi per esterni. Disponibile nella versione a parete. Struttura in estruso di alluminio e viterie in acciaio inox. Driver incluso.

Series of outdoor lighting fittings. Available as wall version. Structure in aluminum. Stainless steel screws. Driver included.

CE	IP65
LED	RG1
CRI 80/90	Driver on/off incl.
L80 B10	50000H
⏚	Mac Adam 3



# LUXA

**X.**  
CRI80  
5

CRI90  
6

A SOFFITTO/ CEILING

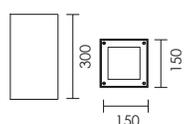

A PARETE/ WALL

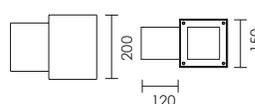

**Z.**  
COLOR

- antracite/anthracite -06
- bianco ragg./rough white -32
- nero ragg. / rough black -33
- grigio chiaro/clear grey -37
- custom -99

COD. ON/OFF	W	K	LM	EMISSIONE / EMISSION
A SOFFITTO/ CEILING				
<b>MTX.5476. 1 X 7. Z</b>	17W/230V LED	4000K	2700	diretta/direct 45°
<b>MTX.5476. 1 X 8. Z</b>	17W/230V LED	3000K	2550	diretta/direct 45°
A PARETE/ WALL				
<b>MTX.5479. 1 X 7. Z</b>	34W/230V LED	4000K	5400	dir+indir 45°- 45°
<b>MTX.5479. 1 X 8. Z</b>	34W/230V LED	3000K	5100	dir+indir 45°- 45°
<b>MTX.5479. 2 X 7. Z</b>	34W/230V LED	4000K	5400	dir+indir 45°- 10°
<b>MTX.5479. 2 X 8. Z</b>	34W/230V LED	3000K	5100	dir+indir 45°- 10°



CE	IP65
LED	RG1
CRI 80/90	Driver on/off incl.
L80 B10	Mac Adam 3
50000H	⏚

- **06-** antracite/anthracite
- **32-** bianco ragg./rough white
- **33-** nero ragg. / rough black
- **37-** grigio chiaro/clear grey
- **99-** custom

**Z.**  
COLOR

# MINI LUXA

**X.**  
CRI80  
**5**

CRI90  
**6**

A PARETE/ WALL

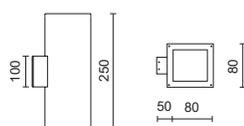

A PARETE/ WALL GU10

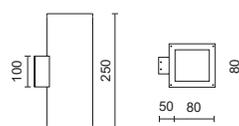

COD. ON/OFF	W	K	EMISSIONE / EMISSION
A PARETE / WALL			
<b>MTX.5475. 1 X 7. Z</b>	6x1,2W/230V LED	4000K	dir+indir 20°- 20°
<b>MTX.5475. 1 X 8. Z</b>	6x1,2W/230V LED	3000K	dir+indir 20°- 20°
A PARETE / WALL GU10			
<b>MTX.35BGUW. Z</b>	2x50W/230V GU10 lamp. esclusa/lamp excluded		dir+indir



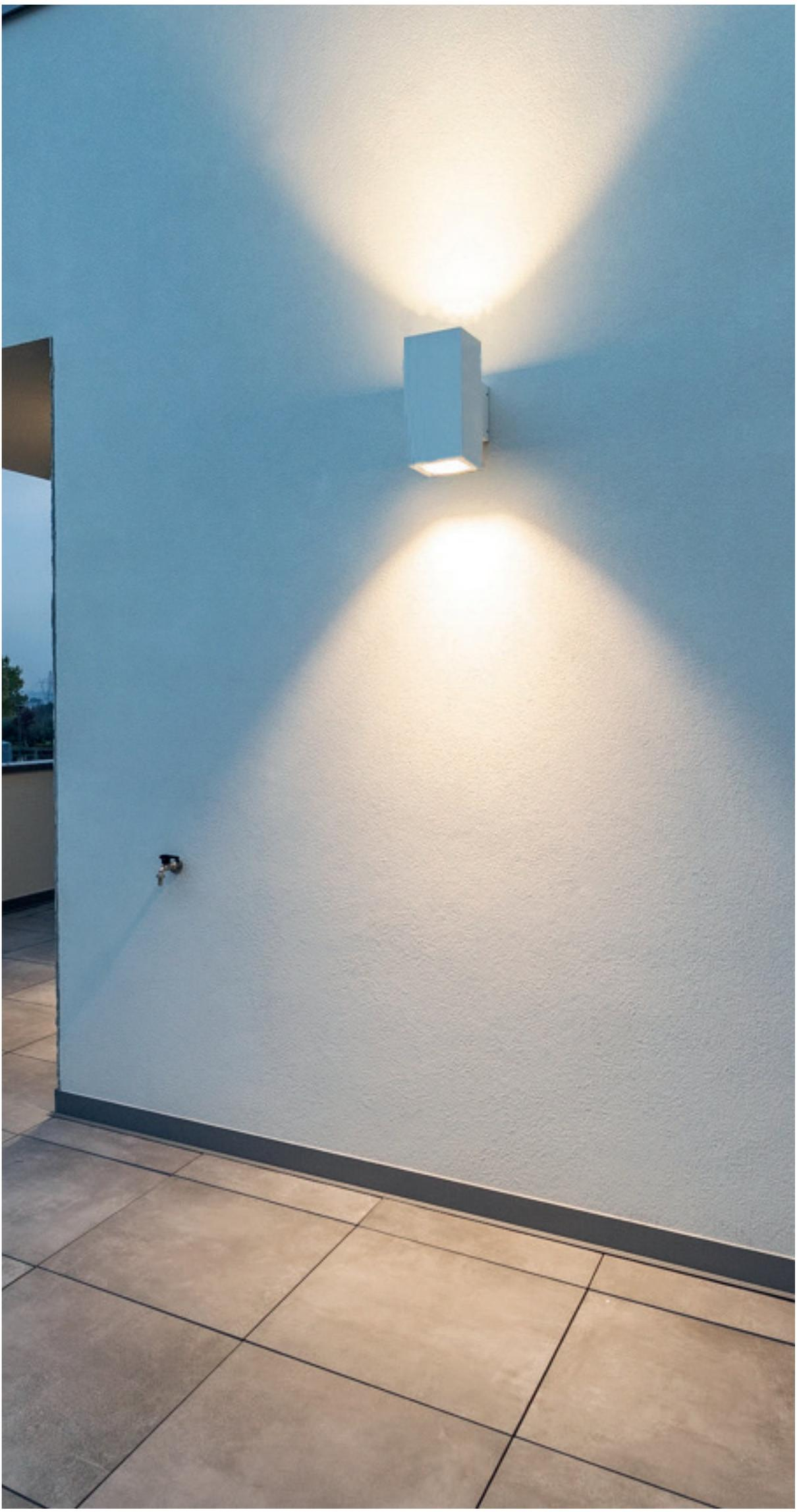

# S I O



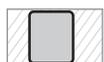
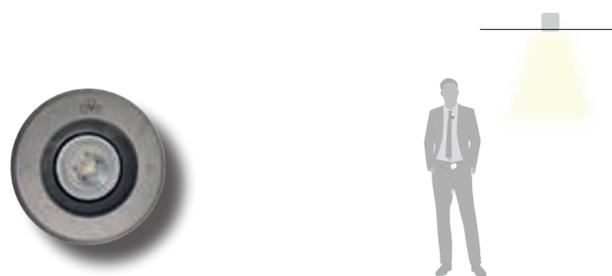

## IOS



Corpo e anello di chiusura in acciaio inox AISI 304. Grado di protezione IP67. Schermo di protezione in vetro trasparente temperato di spessore 10mm con resistenza meccanica IK 10. Guarnizione in gomma al silicone. Ottica fissa con lente. Equipaggiato con LED di colore bianco 4000K o 3000K con potenza 9W o con portalampada GU10, fornito completo di driver integrato nella struttura e di cavo di collegamento H05RN-F 3x1mm<sup>2</sup>. Disponibile anche nella versione RGB con potenza 6W.

Structure and closing ring made of AISI 304 stainless steel. IP67 protection degree. Protection shield made of transparent tempered glass with 10mm thickness and IK 10 shock resistance. Silicone rubber gasket. Fixed or adjustable lens optic. Equipped with one LED in 4000K or 3000K color temperature power 9W or with GU10 lampholder, supplied with built-in driver and H05RN-F 3x1mm<sup>2</sup> connecting cable. Also available in RGB version, power 6W.

CE	IP67
<b>LED</b>	<b>RG1</b>
CRI 80/90	Driver on/off incl.
L80 B10	Mac Adam 3
50000H	



# IOS

**D.**  
OPTIC  
36° 1

OPTIC  
24° 2

OPTIC  
12° 3

**X.**  
CRI80  
5

CRI90  
6

**Y.**  
4000K  
7

3000K  
8

2700K  
9

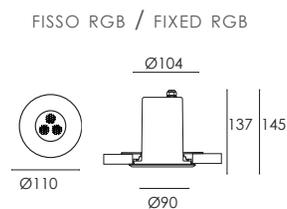
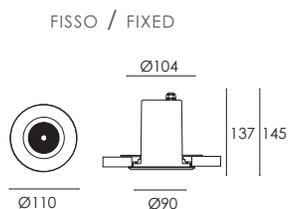

COD. ON/OFF	L.MM	W	LM	DRIVER
		FISSO / FIXED		
<b>IOS.6602.D X Y</b>	Ø110	9W/230V LED	890/840/770	built-in/incorporato
<b>IOS.35FGU</b>	Ø110	20W/230V GU10 lamp. esclusa/lamp excluded		
		FISSO RGB / FIXED RGB	FASCIO/BEAM:25°	
<b>IOS.6602.299</b>	Ø110	6W/24V LED	420	excluded/escluso

## ACCESSORI / ACCESSORIES



**DEO.FG**  
Vetro sabbato.  
Sanded glass.



**DEO.MS**  
Master DEO RGB.

**DEO.SL**  
Slave DEO RGB.





**SEGNAPASSO**

**PATH MARKERS**



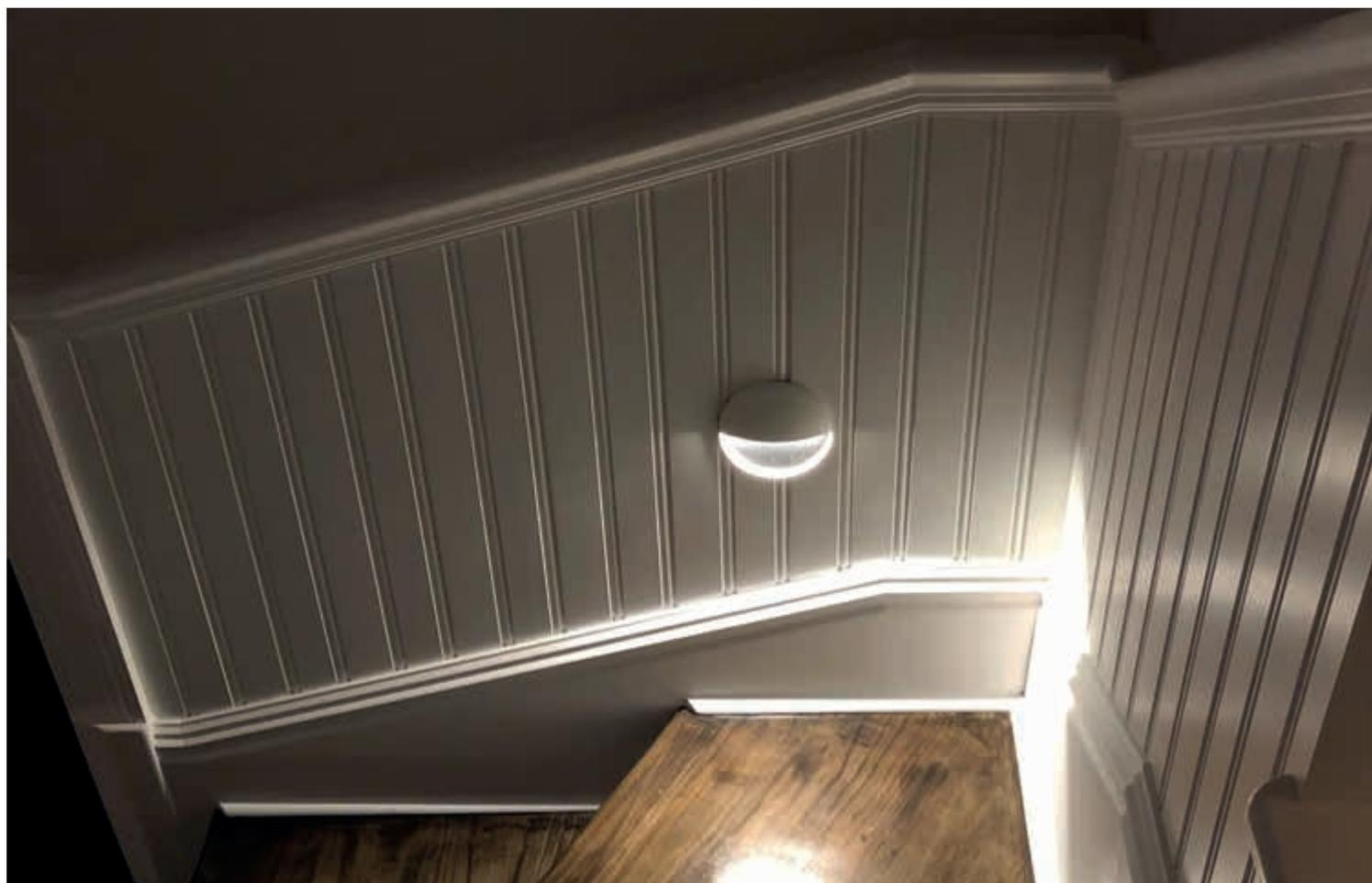



## CARD

Struttura in fusione di alluminio verniciato a polveri epossipoliestere. LED tono luce bianco 4000K o 3000K, emissione diretta asimmetrica. Potenza 2.5W 24V. Grado di protezione IP65. Possono essere fissati direttamente su scatole da incasso di misure standard. Driver remoto escluso.

Structure in die cast aluminum, epoxy polyester powder coating. LED white light tone 4000K or 3000K, direct asymmetric emission. Power 2.5W - 24V. IP65 protection degree. Card can be fixed directly on standard 108x74mm recessed box. Driver remote excluded.



## SOLE

La struttura è in fusione di alluminio verniciato a polveri epossipoliestere. LED tono luce bianco 4000K o 3000K, emissione diretta asimmetrica. Potenza 2.5W 24V. Grado di protezione IP65. Possono essere fissati direttamente su scatole da incasso di misure standard. Driver remoto escluso.

Structure in die cast aluminum, epoxy polyester powder coating. LED white light tone 4000K or 3000K, direct asymmetric emission. Power 2.5W - 24V. IP65 protection degree. Sole can be fixed directly on standard 108x74mm recessed box. Driver remote excluded.

CE	IP65
LED	RG1
CRI 90	Mac Adam 3
L80 B10	50000H



# CARD

CRI90  
6

4000K  
7

3000K  
8

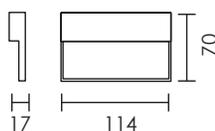

Z.  
COLOR

- antracite/anthracite -06
- bianco ragg./rough white -32
- nero ragg. / rough black -33
- grigio chiaro/clear grey -37
- custom -99

COD. ON/OFF	L.MM	W	K	LM	DRIVER
<b>MTS.5430. 0 6 7. Z</b>	114x70	2.5W/24V LED	4000K	200	driver escluso/ driver excluded
<b>MTS.5430. 0 6 8. Z</b>	114x70	2.5W/24V LED	3000K	200	driver escluso/ driver excluded

## ACCESSORI / ACCESSORIES



**MTS.5428.001**  
Scatola incasso per Card.  
Recessed box for Card.



**AAA.TRSL14**  
LED Driver IP20 8W 24V.



**AAA.TRSL15**  
LED Driver IP66 10W 24V.



CE	IP65
LED	RG1
CRI 90	Mac Adam 3
L80 B10	50000H

- **06**- antracite/anthracite
- **32**- bianco ragg./rough white
- **33**- nero ragg. / rough black
- **37**- grigio chiaro/clear grey
- **99**- custom

**Z.**  
**COLOR**

# SOLE

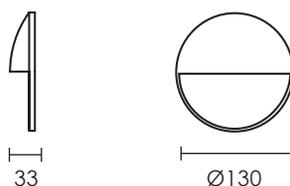

- CRI90  
**6**
- 4000K  
**7**
- 3000K  
**8**

COD. ON/OFF	D.MM	W	K	LM	DRIVER
<b>MTS.5428. 0 6 7. Z</b>	130	2.5W/24V LED	4000K	200	driver escluso/ driver excluded
<b>MTS.5428. 0 6 8. Z</b>	130	2.5W/24V LED	3000K	200	driver escluso/ driver excluded

## ACCESSORI / ACCESSORIES



**MTS.5428.001**  
Scatola incasso per Sole.  
Recessed box for Sole.



**AAA.TRSL14**  
LED Driver IP20 8W 24V.



**AAA.TRSL15**  
LED Driver IP66 10W 24V.



# PROFILI ESTERNI

## Surface and buried profiles





# Outdoor

# ALU PROOF



## ALU PROOF

Alu si caratterizza per la sua estetica semplice adatta a tutti gli spazi di servizio e grazie alla tripla protezione, si installa in qualsiasi contesto, indoor e outdoor.

Il sistema Tri-proof LED della plafoniera ALU la rende tre volte resistente: all'acqua, alla polvere e agli shock. Perfetto per tutti gli spazi ad elevata intensità di utilizzo e condizioni di ambienti variabili, come cantine, negozi, garage, pensiline, ecc.

Profilo in alluminio, con diffusore in policarbonato acidato.

Installabile singolarmente o in file continue.

Alu is characterized by its simple aesthetics, suitable for all service spaces and thanks to the triple protection, it can be installed in any context, indoor and outdoor.

The Tri-proof LED system of the ALU ceiling light makes it three times resistant: to water, dust and shocks. Perfect for all spaces with high intensity of use and conditions of variable environments, such as cellars, shops, garages, shelters, etc.

Aluminum profile, with acid-etched polycarbonate diffuser.

Can be installed individually or in continuous rows.

CE	IP65
LED	RG1
CRI 80/90	Driver on/off incl.
L80 B10	Alu Body
50000H	Mac Adam 3
⏚	

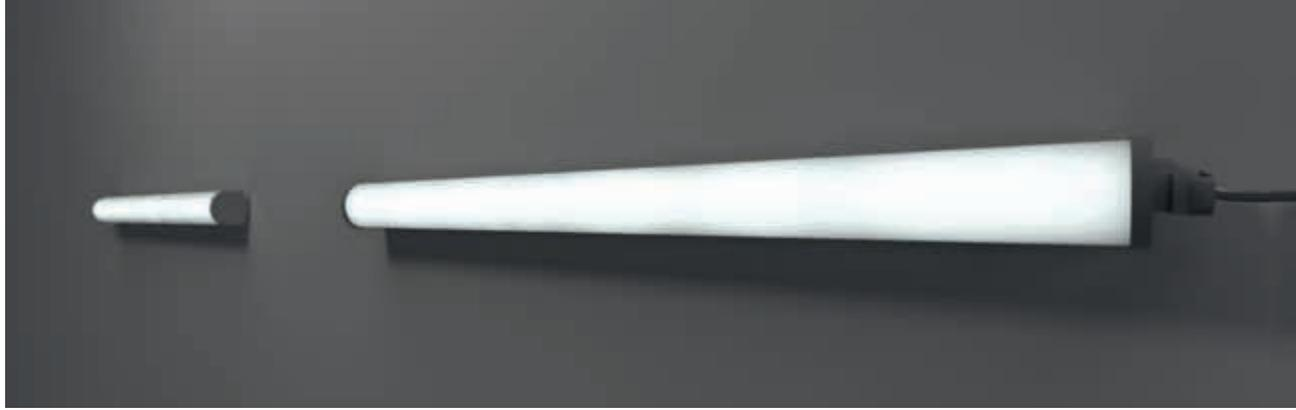

# ALU PROOF

## HIGH LUMINANCE

**Z.** anodizzato / anodised -05

**COLOR**

SINGLE INSTALLATION

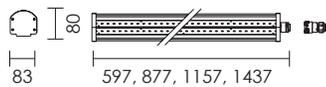

CONTINUOUS INSTALLATION

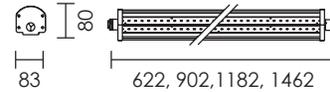

**X.**  
CRI80  
5

CRI90  
6

**Y.**  
4000K  
7

3000K  
8

**DIM**  
1-10V  
A1

DALI  
A2

COD. ON/OFF	L.MM	W	LM	DIFFUSORE/ DIFFUSER
SINGLE INSTALLATION				
NEF.5661. 0 X Y. Z	597	28W/230V LED	3938/3820lm	acidato/frosted
NEF.5662. 0 X Y. Z	877	42W/230V LED	5918/5740lm	acidato/frosted
NEF.5663. 0 X Y. Z	1157	56W/230V LED	7876/7640lm	acidato/frosted
NEF.5664. 0 X Y. Z	1437	70W/230V LED	9856/9560lm	acidato/frosted
CONTINUOUS INSTALLATION				
NEF.5671. 0 X Y. Z	622	28W/230V LED	3938/3820lm	acidato/frosted
NEF.5672. 0 X Y. Z	902	42W/230V LED	5918/5740lm	acidato/frosted
NEF.5673. 0 X Y. Z	1182	56W/230V LED	7876/7640lm	acidato/frosted
NEF.5674. 0 X Y. Z	1462	70W/230V LED	9856/9560lm	acidato/frosted

### ACCESSORI / ACCESSORIES



**NEF.PS**  
Sensore di presenza.  
Presence sensor for ALU.

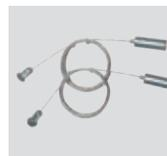

**NEF.SO**  
Sospensione (coppia).  
Suspension (pair).



CE	IP65
LED	RG1
CRI 80/90	Driver on/off incl.
L80 B10	Alu Body
50000H	Mac Adam 3
⏚	

05- anodizzato / anodised **Z.** COLOR

# ALU PROOF

## LOW LUMINANCE



COD. ON/OFF	L.MM	W	LM	DIFFUSORE/ DIFFUSER
SINGLE INSTALLATION				
NEF.5666. 0 X Y. Z	597	17W/230V LED	2630/2380lm	acidato/frosted
NEF.5667. 0 X Y. Z	877	27W/230V LED	3945/3570lm	acidato/frosted
NEF.5668. 0 X Y. Z	1157	36W/230V LED	5260/4760lm	acidato/frosted
NEF.5669. 0 X Y. Z	1437	44W/230V LED	6575/5950lm	acidato/frosted
CONTINUOUS INSTALLATION				
NEF.5676. 0 X Y. Z	622	17W/230V LED	2630/2380lm	acidato/frosted
NEF.5677. 0 X Y. Z	902	27W/230V LED	3945/3570lm	acidato/frosted
NEF.5678. 0 X Y. Z	1182	36W/230V LED	5260/4760lm	acidato/frosted
NEF.5679. 0 X Y. Z	1462	44W/230V LED	6575/5950lm	acidato/frosted

X. CRI80  
5

CRI90  
6

Y. 4000K  
7

3000K  
8

DIM 1-10V  
A1

DALI  
A2

### ACCESSORI / ACCESSORIES



**NEF.PS**  
Sensore di presenza.  
Presence sensor for ALU.



**NEF.SO**  
Sospensione (coppia).  
Suspension (pair).





# NET







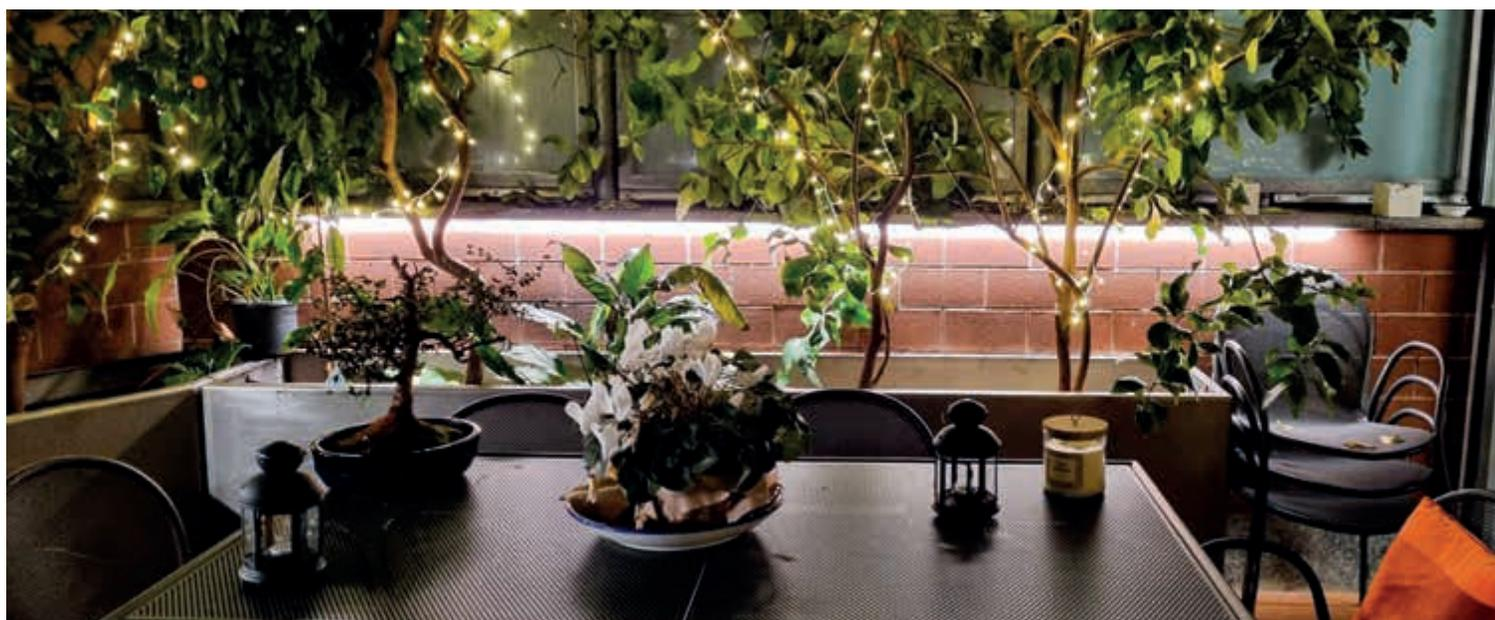

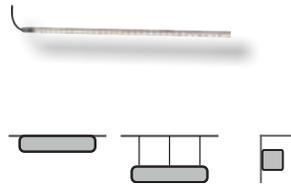

## NET 16

Net 16 ha struttura interna in alluminio estruso, testate in lega di alluminio tornito sottoposte a trattamento di anodizzazione galvanica, diffusore in policarbonato trasparente o opale. Tono luce bianco 4000K o 3000K, potenze da 9.6W/1050mm a 43.2W/3050mm. Staffe di fissaggio e cavo di collegamento H05RN-F 2x1mm<sup>2</sup> inclusi. Driver remoto da ordinare separatamente.

Net 16 has internal structure in extruded aluminum, end caps in turned aluminum alloy with galvanic anodizing treatment. Transparent or opal polycarbonate diffuser. 4000K or 3000K LED white tone, power from 9.6W/1050mm to 43.2W/3050mm. Supplied with fixing brackets and H05RN-F 2x1mm<sup>2</sup> connecting cable. Remote driver to be ordered separately.

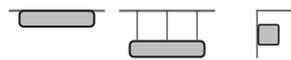

## NET 50

Net 50 ha struttura interna in alluminio estruso, testate in lega di alluminio tornito sottoposte a trattamento di anodizzazione galvanica, diffusore in policarbonato esterno trasparente, interno satinato per luce diffusa o con lenti per luce concentrata. Tono bianco 4000K o 3000K, potenze da 30W/1170mm a 42x1.2/1790mm. Alimentatore elettronico incluso.

Net 50 has internal structure in extruded aluminum, end caps in turned aluminum alloy with galvanic anodizing treatment, External transparent polycarbonate diffuser with internal Opal screen for diffuse emission or with lenses for concentrate light. 4000K or 3000K LED white tone, power from 30W/1170mm to 42x1.2W/1790mm. Electronic driver included.

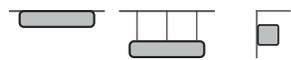

## NET 70

Net 70 ha struttura interna in alluminio, testate in tecnopolimero resistente agli agenti atmosferici, diffusore in policarbonato opale. Tono luce bianco 4000K o 3000K, potenze da 38W /1257mm a 58W/1817mm. Alimentatore elettronico incluso.

Net 70 has internal structure in aluminum, end caps in weather-resistant techno polymer, opal polycarbonate diffuser. 4000K or 3000K LED white tone, power from 38W /1257mm to 58W/1817mm. Electronic driver included.

CE	IP65
LED	RG1
CRI 90	Mac Adam 3
L80 B10	50000H
	



# NET 16

COLOR anodizzato / anodised -05

Y.  
4000K  
7

3000K  
8

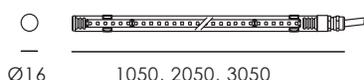

COD. ON/OFF	L.MM	W	LM	DIFFUSORE/ DIFFUSER
120 LED/M				
NES.3341.1 6 Y. Z	1050	9,6W/24V LED	780/720	trasparente/clear
NES.3341.2 6 Y. Z	2050	19,2W/24V LED	1560/1440	trasparente/clear
NES.3341.3 6 Y. Z	3050	28,8W/24V LED	2340/2160	trasparente/clear
60 LED/M				
NES.3351.1 6 Y. Z	1050	9,6W/24V LED	780/720	opale/opal
NES.3351.2 6 Y. Z	2050	19,2W/24V LED	1560/1440	opale/opal
NES.3351.3 6 Y. Z	3050	28,8W/24V LED	2340/2160	opale/opal
NES.3342.1 6 Y. Z	1050	14,4W/24V LED	1060/990	trasparente/clear
NES.3342.2 6 Y. Z	2050	28,8W/24V LED	2120/1980	trasparente/clear
NES.3342.3 6 Y. Z	3050	43,2W/24V LED	3180/2970	trasparente/clear
NES.3352.1 6 Y. Z	1050	14,4W/24V LED	1060/990	opale/opal
NES.3352.2 6 Y. Z	2050	28,8W/24V LED	2120/1980	opale/opal
NES.3352.3 6 Y. Z	3050	43,2W/24V LED	3180/2970	opale/opal

## ACCESSORI / ACCESSORIES



- AAA.TRSL08 Driver LED IP20 30W.
- AAA.TRSL09 Driver LED IP20 75W.
- AAA.TRSL10 Driver LED IP20 150W.
- AAA.TRSL13 Driver LED IP67 70W.
- AAA.TRSL15 Driver LED IP65 10W.

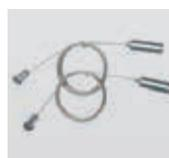

- NES.SO  
Sospensioni (coppia).  
Suspension kit (pair).



CE	IP67
LED	RG1
CRI 90	Driver on/off incl.
L80 B10	50000H
⏚	Mac Adam 3

■ 05- anodizzato/anodised

COLOR

# NET 50

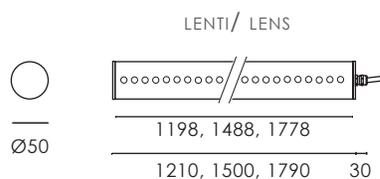
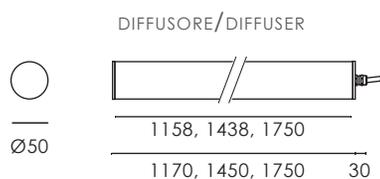

D.  
15°  
1

30°  
2

10x45°  
3

Y.  
4000K  
7

3000K  
8

DIM.  
1-10V  
A1

DALI  
A2

COD. ON/OFF	L.MM	W	LM	FASCIO/ BEAM
DIFFUSORE/DIFFUSER				
NET.5743.0 6 Y. Z	1170	30W/230V LED	2304/2088	diffuso/ diffuse
NET.5744.0 6 Y. Z	1450	37W/230V LED	2930/2657	diffuso/ diffuse
NET.5745.0 6 Y. Z	1750	45W/230V LED	3560/3226	diffuso/ diffuse
LENTI/LENSES				
NET.5746.D 6 Y. Z	1210	28x1,2W/230V LED	3016/2590	15°-30°-10x45°
NET.5747.D 6 Y. Z	1500	35x1,2W/230V LED	3769/3237	15°-30°-10x45°
NET.5748.D 6 Y. Z	1790	42x1,2W/230V LED	4272/3669	15°-30°-10x45°

## ACCESSORI / ACCESSORIES



**NET.S05**  
Sospensioni (coppia).  
Suspension kit (pair).



**NET.AP5**  
Attacco a parete o soffitto (coppia).  
Wall or ceiling attachment (pair).

CE	IP65
LED	RG1
CRI 80/90	Driver on/off incl.
L80 B10	50000H
	MacAdam 3

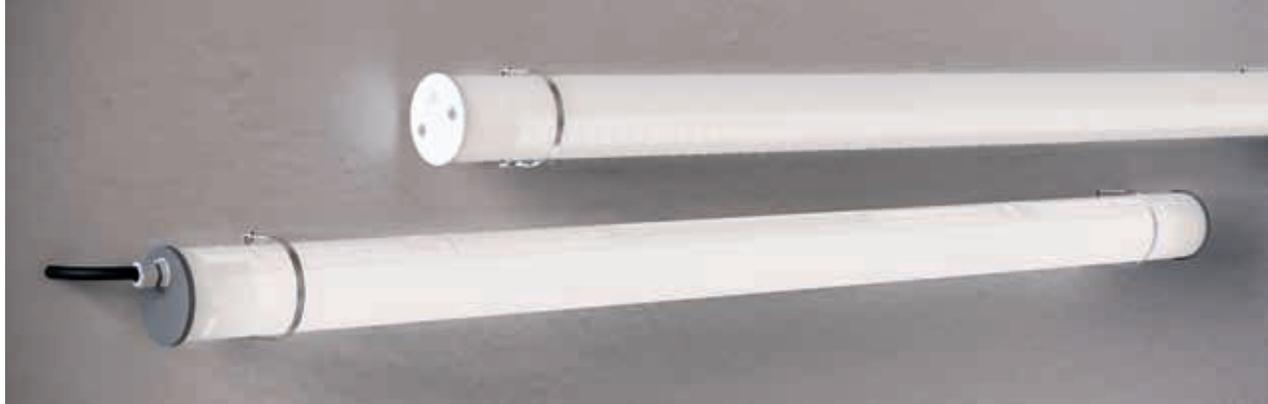

# NET 70

**Z.** grigio metallico/ metallic grey -28 

**X.**  
CRI80  
5

CRI90  
6

**DIM**  
1-10V  
A1

DALI  
A2

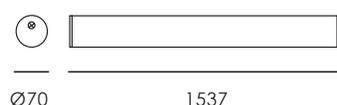
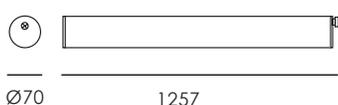

COD. ON/OFF	L.MM	W	K	LM	DIFFUSORE/ DIFFUSER
<b>NEV.5713.1 X 7. Z</b>	1257	38W/230V LED	4000K	5640	opale/opal
<b>NEV.5713.1 X 8. Z</b>	1257	38W/230V LED	3000K	5320	opale/opal
<b>NEV.5714.1 X 7. Z</b>	1537	48W/230V LED	4000K	7060	opale/opal
<b>NEV.5714.1 X 8. Z</b>	1537	48W/230V LED	3000K	6660	opale/opal
<b>NEV.5715.1 X 7. Z</b>	1817	58W/230V LED	4000K	8480	opale/opal
<b>NEV.5715.1 X 8. Z</b>	1817	58W/230V LED	3000K	8000	opale/opal

## ACCESSORI / ACCESSORIES



**NEV.AP2**  
Attacco a parete o soffitto. (coppia)  
Wall or ceiling mount (pair).



**NEV.AP4**  
Attacco a parete o soffitto. (coppia)  
Wall or ceiling mount (pair).



**NEV.SO**  
Sospensioni (coppia).  
Suspension kit (pair).



# CABRIO

Cabrio  
Cabrio RGBW

Famiglia di apparecchi lineari per esterno dal design contemporaneo che ci aiuta inserire la luce dove l'architettura l'ha sottratta: facciate di edifici, volte, portoni e pensiline. Grazie ai molteplici fasci disponibili è facile trovare la soluzione che più si adatta alle proprie esigenze che siano quelle di far risaltare un dettaglio o di realizzare un'illuminazione funzionale e/o decorativa.

A family of linear outdoor luminaires with a contemporary design that helps us insert light where architecture has stolen it: building facades, vaults, doors and canopies. Thanks to the multiple beams available, it is easy to find the solution that best suits your needs, whether they are to bring out a detail or to create functional and/or decorative lighting.



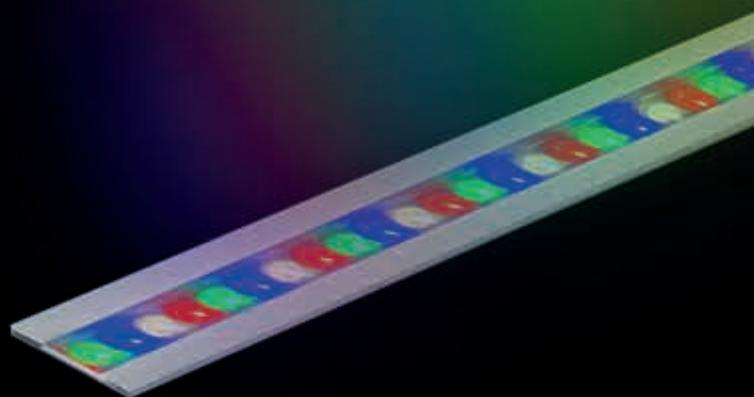

Cabrio Recessed  
Cabrio Recessed RGBW



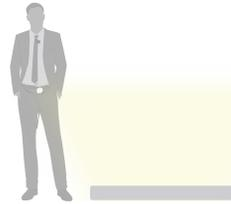

## CABRIO

Struttura interamente in alluminio estruso con finitura anodizzata ad elevata resistenza all'ossidazione. Diffusore in vetro temperato spessore 6 mm, satinato per luce diffusa o trasparente con lenti. Viti a brugola in acciaio INOX A4. Apparecchio precablato con cavo in neoprene, guarnizioni in silicone ricotto. Tono luce bianco 4000K o 3000K, Potenze da 12.5W/605mm a 28x1.2W/1205mm. Alimentatore elettronico incluso.

The structure is made of extruded aluminum, anodized finishing with high resistance against corrosion, tempered glass diffuser 6mm thick, frosted for diffuse light or transparent with lenses. Screws in stainless steel A4, prewired with neoprene cable, silicone gaskets. 4000K or 3000K LED white tone, from 12.5W/605mm to 28x1.2W/1205mm power. Electronic driver included.



## CABRIO RGBW

Struttura interamente in alluminio estruso con finitura anodizzata ad elevata resistenza all'ossidazione. Diffusore in vetro temperato spessore 6 mm, satinato per luce diffusa o trasparente con lenti. Viti a brugola in acciaio INOX A4. Apparecchio precablato con cavo in neoprene, guarnizioni in silicone ricotto. Tono luce RGBW. Potenze da 24x1.2W/615mm a 48x1.2W/1215mm. Driver DMX incluso.

The structure is made of extruded aluminum, anodized finishing with high resistance against corrosion, tempered glass diffuser 6mm thick, frosted for diffuse light or transparent with lenses. Screws in stainless steel A4, prewired with neoprene cable, silicone gaskets. RGBW tone, from 24x1.2W/615mm to 48x1.2W/1215mm power. DMX driver included.

CE	IP65
LED	RG1
CRI 80	Driver on/off incl.
L80 B10	50000H
	MacAdam 3



# CABRIO

Z.  
COLOR

- anodizzato/anodised -05 
- antracite/anthracite -06 
- grigio chiaro opaco/clear matt grey -37 
- custom -99 

15°  
1

30°  
2

10x45°  
3

11x30°  
4

CR180  
5

Y.  
4000K  
7

3000K  
8

DIM.  
1-10V  
A1

DALI  
A2

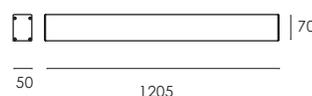

COD. ON/OFF	L.MM	W	LM	FASCIO / BEAM
JEC.5916.0 5 Y. Z	605	12.5W/230V LED	1585/1502	diffuso/diffuse 120°
JEC.5921.1 5 Y. Z	605	14x1.2W/230V LED	1502/1295	stretto/narrow 15°
JEC.5921.2 5 Y. Z	605	14x1.2W/230V LED	1502/1295	largo/wide 30°
JEC.5921.3 5 Y. Z	605	14x1.2W/230V LED	1502/1295	ellittico/elliptical 10x45°
JEC.5921.4 5 Y. Z	605	14x1.2W/230V LED	1502/1295	ellittico/elliptical 11x30°
JEC.5918.0 5 Y. Z	1205	25W/230V LED	3170/3004	diffuso/diffuse 120°
JEC.5923.1 5 Y. Z	1205	28x1.2W/230V LED	3016/2590	stretto/narrow 15°
JEC.5923.2 5 Y. Z	1205	28x1.2W/230V LED	3016/2590	largo/wide 30°
JEC.5923.3 5 Y. Z	1205	28x1.2W/230V LED	3016/2590	ellittico/elliptical 10x45°
JEC.5923.4 5 Y. Z	1205	28x1.2W/230V LED	3016/2590	ellittico/elliptical 11x30°

## ACCESSORI / ACCESSORIES



**JEC.AP**  
Attacchi a parete (coppia).  
Wall mount (pair).



**AAA.CN3**  
Connettore IP68, 3vie.  
IP68 waterproof connector, 3way.



**JEC.APR**  
Ganci di fissaggio regolabili (coppia).  
Fixing adjustable hook (pair).



**AAA.CN4**  
Connettore IP68, 4vie.  
IP68 waterproof connector, 4way.



CE	IP65
LED	RG1
Mac Adam 3	50000H
L80 B10	RGBW
⏚	

- 05**- anodizzato/anodised
- 06**- antracite/anthracite
- 37**- grigio chiaro opaco/clear matt grey
- 99**- custom

**Z.**  
COLOR

# CABRIO

## RGBW

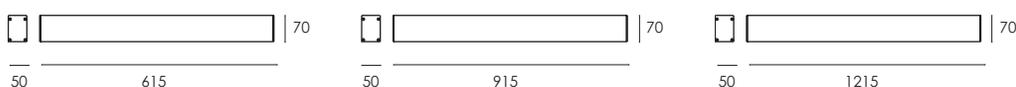

**D.**  
15°  
1

30°  
2

10X45°  
3

COD. ON/OFF	L.MM	W	DRIVER
			RGBW
<b>JEC.5931.D 99. Z</b>	615	24x1.2W/230V RGBW	driver-dmx incluso/ driver-dmx included
<b>JEC.5932.D 99. Z</b>	915	36x1.2W/230V RGBW	driver-dmx incluso/ driver-dmx included
<b>JEC.5933.D 99. Z</b>	1215	48x1.2W/230V RGBW	driver-dmx incluso/ driver-dmx included

### ACCESSORI / ACCESSORIES



**AAA.TRSL27N**  
Centralina di controllo RGBW.  
RGBW control unit.



**JEC.AP**  
Attacchi a parete (coppia).  
Wall mount (pair).



**JEC.APR**  
Ganci di fissaggio (coppia).  
Fixing hook (pair).



**AAA.CN3**  
Connettore IP68, 3vie.  
IP68 waterproof connector, 3way.



**AAA.CN4**  
Connettore IP68, 4vie.  
IP68 waterproof connector, 4way.





## CABRIO RECESSED

Struttura interamente in alluminio estruso con finitura anodizzata ad elevata resistenza all'ossidazione. Diffusore in vetro temperato spessore 6 mm, satinato per luce diffusa o trasparente con lenti. Viti a brugola in acciaio INOX A4. Apparecchio precablato con cavo in neoprene, guarnizioni in silicone ricotto. Tono luce bianco 4000K o 3000K, Potenze da 12.5W/605mm a 28x1.2W/1205mm. Alimentatore elettronico incluso. L'apparecchio va utilizzato con l'apposita cassaforma in lamiera di acciaio zincato zincato dotata di alette per impedirne la deformazione da ordinare separatamente.

The structure is made of extruded aluminum, anodized finishing with high resistance against corrosion, tempered glass diffuser 6mm thick, frosted for diffuse light or transparent with lenses. Screws in stainless steel A4, prewired with Neoprene Cable, Silicone Gaskets. 4000K or 3000K LED white tone, from 12.5W/605mm to 28x1.2W/1205mm power. Electronic driver included. Recessed box in steel to be ordered separately.



## CABRIO RECESSED RGBW

Struttura interamente in alluminio estruso con finitura anodizzata ad elevata resistenza all'ossidazione. Diffusore in vetro temperato spessore 6 mm, satinato per luce diffusa o trasparente con lenti. Viti a brugola in acciaio INOX A4. Apparecchio precablato con cavo in neoprene, guarnizioni in silicone ricotto. Tono luce RGBW, Potenze da 24x1.2W/615mm a 48x1.2W/1215mm. Driver DMX incluso. L'apparecchio va utilizzato con l'apposita cassaforma in lamiera di acciaio zincato zincato dotata di alette per impedirne la deformazione da ordinare separatamente.

The structure is made of extruded aluminum, anodized finishing with high resistance against corrosion, tempered glass diffuser 6mm thick, frosted for diffuse light or transparent with lenses. Screws in stainless steel A4, prewired with Neoprene Cable, Silicon Gaskets. RGBW tone, power from 24x1.2W /615mm to 48x1.2W/1215mm power. DMX driver included.

CE	IP67
LED	RG1
CRI 80	Driver on/off incl.
L80 B10	50000H
	MacAdam 3



# CABRIO

## RECESSED

Z  
COLOR

- anodizzato/anodised -05 
- antracite/anthracite -06 
- grigio chiaro opaco/clear matt grey -37 
- custom -99 

15°  
1

30°  
2

10x45°  
3

11x30°  
4

CRI80  
5

Y.  
4000K  
7

3000K  
8

DIM.  
1-10V  
A1

DALI  
A2

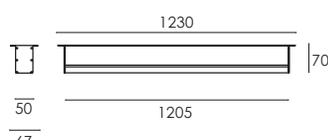
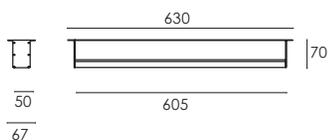

COD. ON/OFF	L.MM	W	LM	FASCIO / BEAM
<b>JED.5916.0 5 Y. Z</b>	605	12.5W/230V LED	1585/1502	diffuso/diffuse 120° SYM
<b>JED.5951.1 5 Y. Z</b>	605	14x1.2W/230V LED	1502/1295	stretto/narrow 15° SYM
<b>JED.5951.2 5 Y. Z</b>	605	14x1.2W/230V LED	1502/1295	largo/wide 30° SYM
<b>JED.5951.3 5 Y. Z</b>	605	14x1.2W/230V LED	1502/1295	ellittico/ellip. 10x45° SYM
<b>JED.5951.4 5 Y. Z</b>	605	14x1.2W/230V LED	1502/1295	ellittico/ellip. 11x30° SYM
<b>JED.5918.0 5 Y. Z</b>	1205	25W/230V LED	3170/3004	diffuso/diffuse 120° SYM
<b>JED.5953.1 5 Y. Z</b>	1205	28x1.2W/230V LED	3016/2590	stretto/narrow 15° SYM
<b>JED.5953.2 5 Y. Z</b>	1205	28x1.2W/230V LED	3016/2590	largo/wide 30° SYM
<b>JED.5953.3 5 Y. Z</b>	1205	28x1.2W/230V LED	3016/2590	ellittico/ellip. 10x45° SYM
<b>JED.5953.4 5 Y. Z</b>	1205	28x1.2W/230V LED	3016/2590	ellittico/ellip. 11x30° SYM

### ACCESSORI / ACCESSORIES



**JED.C24** L.630mm.  
**JED.C54** L.1230mm.  
Cassaforma per incasso.  
Recessed housing.



**AAA.CN3**  
Connettore IP68, 3vie.  
IP68 waterproof connector, 3way.



**JED.CD**  
Giunto lineare.  
Linear joint.



**AAA.CN4**  
Connettore IP68, 4vie.  
IP68 waterproof connector, 4way.





CE	IP67
LED	RG1
Mac Adam 3	50000H
L80 B10	RGBW

- 05**- anodizzato/anodised
  - 06**- antracite/anthracite
  - 37**- grigio chiaro opaco/clear matt grey
  - 99**- custom
- Z**  
 COLOR

# C A B R I O

## R E C E S S E D   R G B W

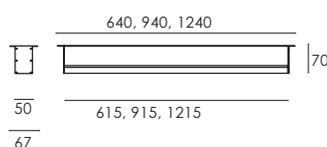

- D.**  
15°  
**1**
- 30°  
**2**
- 10X45°  
**3**

COD. ON/OFF	L.MM	W	DRIVER
<b>JED.5941.D 99. Z</b>	615	24x1.2W/230V RGBW	driver-dmx incluso/ driver-dmx included
<b>JED.5942.D 99. Z</b>	915	36x1.2W/230V RGBW	driver-dmx incluso/ driver-dmx included
<b>JED.5943.D 99. Z</b>	1215	48x1.2W/230V RGBW	driver-dmx incluso/ driver-dmx included

### ACCESSORI / ACCESSORIES



- JED.C41** L.640mm.
- JED.C42** L.940mm.
- JED.C43** L.1240mm.

Cassaforma per incasso.  
Recessed housing.



- JED.CD**  
Giunto lineare.  
Linear joint.



- AAA.CN3**  
Connettore IP68, 3vie.  
IP68 waterproof connector, 3way.



- AAA.TRS127N**  
Centralina di controllo RGBW.  
RGBW control unit.



- AAA.CN4**  
Connettore IP68, 4vie.  
IP68 waterproof connector, 4way.

# RAISE





## RAISE

Profilo carrabile in estruso di alluminio. Diffusore in vetro temperato (spessore 6 mm). Testate in alluminio pressofuso, guarnizioni in silicone e viteria in acciaio inox A4. Driver escluso da ordinare separatamente.

The structure is made of extruded aluminum. Tempered glass diffuser (6mm thick). Die-cast aluminum end caps, silicone gaskets and stainless steel A4 screws. Driver not included to be ordered separately.

CE	IP67
LED	RG1
CRI 80/90	Mac Adam 3
L80 B10	Driveover Carrabile
50000H	



# RAISE

**Z.**  
**COLOR** grigio chiaro opaco/clear matt grey -37

**X.**  
CRI80  
5

CRI90  
6

**Y.**  
4000K  
7

3000K  
8

**DIM.**  
1-10V  
A1

DALI  
A2

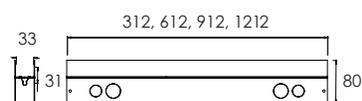

COD. ON/OFF	L.MM	W	LM	FASCIO / BEAM	DRIVER
JER.5850.0 X Y. Z	310	7.5W/24V LED	576/522	108°	driver escluso/ driver excluded
JER.5851.0 X Y. Z	610	15W/24V LED	1152/1044	108°	driver escluso/ driver excluded
JER.5852.0 X Y. Z	910	22.5W/24V LED	1728/1560	108°	driver escluso/ driver excluded
JER.5853.0 X Y. Z	1210	30W/24V LED	2304/2088	108°	driver escluso/ driver excluded

## ACCESSORI / ACCESSORIES



**JER.5850.000** L.310mm.  
**JER.5850.001** L.610mm.  
**JER.5850.002** L.910mm.  
**JER.5850.003** L.1210mm.

Cassaforma per incasso.  
Recessed housing



**JER.5850.011**  
Testata di chiusura per cassaforma.  
End cap for recessed housing.



**JER.5850.010**  
Giunto per cassaforma.  
Linear joint for recessed housing.



**AAA.TRSL08**  
LED Driver IP20 30W 24VDC.

**AAA.TRSL09**  
LED Driver IP20 75W 24VDC



**AAA.TRSL13**  
LED Driver IP67 70W 24VDC.

**AAA.TRSL16**  
LED Driver IP67 150W 24VDC



# SPIDER

Famiglia di incassi a pavimento per uso esterno disponibile in più versioni con diverse tipologie di fasci. Possono essere utilizzati singolarmente o in fila continua, per installazioni a parete o a pavimento. Sono adatti ad illuminare corridoi, portici o camminamenti, ma anche grandi opere architettoniche o open-space.

Family of floor recessed luminaires for outdoor use available in several versions with different types of beams, they can be used individually or in a continuous row, for wall or floor installations. They are suitable for lighting corridors, porches or walkways, but also for large architectural works and open-spaces.

# Spider Recessed

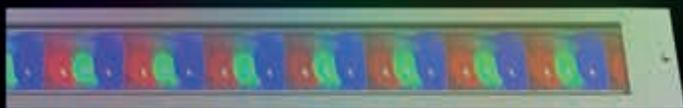
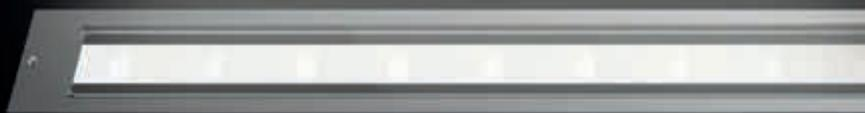

# Spider Recessed RGB





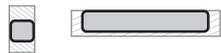
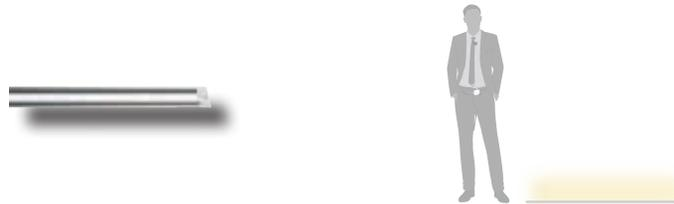

## SPIDER RECESSED

Struttura in alluminio estruso con finitura anodizzata ad elevata resistenza all'ossidazione. Testate in lega di alluminio pressofuso. Diffusore in vetro temperato spessore 6 mm, satinato per luce diffusa o trasparente con lenti. Viti a brugola in acciaio INOX A4. Apparecchio precablato con cavo in neoprene, guarnizioni in silicone ricotto. Tono luce bianco 4000K o 3000K, Potenze da 12.5W/660mm a 28W/1260mm. Alimentatore elettronico incluso. Cassaforma da ordinare separatamente.

The structure is made of extruded aluminum, anodized finishing with high resistance against corrosion, end-caps in aluminum alloy, tempered glass diffuser 6mm thick, frosted for diffuse light or transparent with lenses. Screws in stainless steel A4, prewired with neoprene cable, silicone gaskets. 4000K or 3000K LED white tone, from 12.5W/660mm to 28W/1260mm power. Electronic driver included. Recessed box in steel to be ordered separately.



## SPIDER RECESSED RGB



Struttura in alluminio estruso finitura anodizzato ad elevata resistenza all'ossidazione. Testate in lega di alluminio pressofuso. Diffusore in vetro temperato spessore 6 mm trasparente con lenti. Viti a brugola in acciaio INOX A4. Apparecchio precablato con cavo in neoprene, guarnizioni in silicone ricotto. Potenze da 18led/960mm a 27led /1260mm. Alimentatore e cassaforma da ordinare separatamente.

The structure is made of extruded aluminum, anodized finishing with high resistance against corrosion, end-caps in aluminum alloy, tempered glass diffuser 6mm thick, transparent with lenses. Screws in stainless steel A4, prewired with Neoprene Cable, Silicon Gaskets, from 18leds/960mm to 27leds/1260mm power. Electronic driver and recessed box in steel to be ordered separately.

CE	IP67
LED	RG1
CRI 80	Driver on/off incl.
L80 B10	50000H
	Mac Adam 3



# SPIDER

## RECESSED

Z. COLOR

- anodizzato/anodised -05 
- antracite/anthracite -06 
- grigio chiaro opaco/clear matt grey -37 
- custom -99 

15°  
1

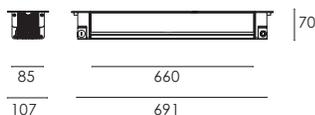

30°  
2

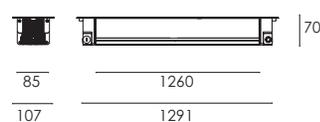

10x45°  
3

11x30°  
4

CRI80  
5

Y.  
4000K  
7

3000K  
8

DIM.  
1-10V  
A1

DALI  
A2

COD. ON/OFF	L.MM	W	LM	FASCIO / BEAM
JAD.5816.0 5 Y. Z	660	12.5W/230V LED	1585/1502	diffuso/diffuse 120° SYM
JAD.5821.1 5 Y. Z	660	14x1.2W/230V LED	1502/1295	stretto/narrow 15° ASYM
JAD.5821.2 5 Y. Z	660	14x1.2W/230V LED	1502/1295	largo/wide 30° ASYM
JAD.5821.3 5 Y. Z	660	14x1.2W/230V LED	1502/1295	ellittico/ellip. 10x45° ASYM
JAD.5821.4 5 Y. Z	660	14x1.2W/230V LED	1502/1295	ellittico/ellip. 11x30° ASYM
JAD.5818.0 5 Y. Z	1260	25W/230V LED	3170/3004	diffuso/diffuse 120° SYM
JAD.5823.1 5 Y. Z	1260	28x1.2W/230V LED	3016/2590	stretto/narrow 15° ASYM
JAD.5823.2 5 Y. Z	1260	28x1.2W/230V LED	3016/2590	largo/wide 30° ASYM
JAD.5823.3 5 Y. Z	1260	28x1.2W/230V LED	3016/2590	ellittico/ellip. 10x45° ASYM
JAD.5823.4 5 Y. Z	1260	28x1.2W/230V LED	3016/2590	ellittico/ellip. 11x30° ASYM

### ACCESSORI / ACCESSORIES



JAD.C24 L.691mm.  
JAD.C54 L.1291mm.  
Cassaforma per incasso.  
Recessed housing.



JAD.PC  
Pressacavo IP67.  
Cable gland IP67.



DUC.MF3  
Gancio di fissaggio (coppia)  
Fixing hook (pair)



AAA.CN3  
Connettore IP68, 3vie  
IP68 waterproof connector, 3way



JAD.CA  
Cavo anticaduta.  
Suspension cable



AAA.CN4  
Connettore IP68, 4vie.  
IP68 waterproof connector, 4way



CE	IP67
LED	RG1
Mac Adam 3	50000H
L80 B10	RGB

- 05-** anodizzato/anodised
- 06-** antracite/anthracite
- 37-** grigio chiaro opaco/clear matt grey
- 99-** custom

**Z.**  
COLOR

# SPIDER

## RECESSED RGB

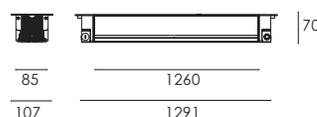
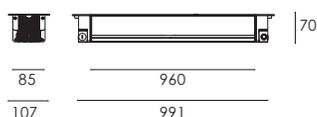

**D.**  
15°  
1

30°  
2

10X45°  
3

11X30°  
4

COD. ON/OFF	L.MM	W	LM	FASCIO / BEAM	DRIVER
<b>JAD.5837.D 99. Z</b>	960	18x1.2W/230V RGB	478	ASYM	driver escluso/ driver excluded
<b>JAD.5838.D 99. Z</b>	1260	27x1.2W/230V RGB	718	ASYM	driver escluso/ driver excluded

### ACCESSORI / ACCESSORIES



**JAD.C21** L.991mm.  
**JAD.C54** L.1291mm.  
Cassaforma per incasso.  
Recessed housing.



**AAA.TRSL23**  
Driver RGB  
Driver RGB



**DUC.MF3**  
Gancio di fissaggio (coppia).  
Fixing hook (pair)



**AAA.TRSL26**  
Controllo ad infrarossi.  
Infrared system



**JAD.CA**  
Cavo anticaduta.  
Suspension cable



**AAA.TRSL27**  
Centralina di controllo DMX.  
DMX control unit.



**JAD.PC**  
Pressacavo IP67.  
Cable gland IP67.



**AAA.CN3**  
Connettore IP68, 3vie.  
IP68 waterproof connector, 3way.



**AAA.TRSL25**  
Interfaccia DMX.  
DMX interface.



**AAA.CN4**  
Connettore IP68, 4vie.  
IP68 waterproof connector, 4way.

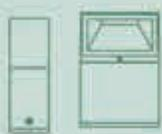

# PALETTI E PROIETTORI

## Poles & projectors



Outdoor

# MINI ORFEO PRO



Mini Orfeo Pro è un apparecchio orientabile per esterni dal design essenziale, caratterizzato dalla forma quadrata. L'ampia disponibilità di modelli permette di creare effetti di illuminazione differenti. Pensato per l'esterno per illuminare porticati, scale balconate e terrazzi.

Mini Orfeo Pro is an adjustable outdoor light fitting spotlight with an essential design, characterised by its square shape. The wide range of variations allows you to create different lighting effects. Designed for outdoors to illuminate porches, stairs, balconies and terraces.



## MINI ORFEO PRO

La struttura è in fusione di alluminio verniciato a polveri epossipoliestere. Vetro temperato trasparente. LED: tono luce bianco 4000K o 3000K. Dotato di ottiche o di riflettori sia metallizzati rosimmetrici di diversi fasci o in alluminio a fascio diffuso. Potenze a partire da 1750 lm fino a 2650 lm.

The structure is in die cast aluminum powder coated LED. Tempered transparent safety glass. 4000K or 3000K white light tone. Equipped with Lenses or reflectors with different beams. Powers from 1750 lm up to 2650 lm.

Scopri anche / look at:

**Mini Orfeo**  
pag. 36  
Esterni a soffitto & parete  
Exterior wall & ceiling



CE	IP65
LED	RG1
CRI 80/90	Driver on/off incl.
L80 B10	Mac Adam 3
50000H	



# MINI ORFEO PRO

Z. COLOR

- antracite/anthracite -06 
- grigio chiaro/clear grey -37 
- custom -99 

X. CRI80 5

CRI90 6

Y. 4000K 7

3000K 8

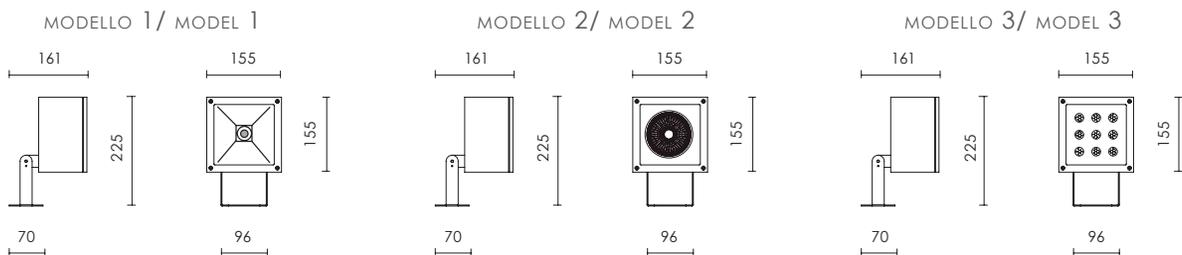

COD. ON/OFF	W	LM	FASCIO / BEAM	DIFFUSORE/ DIFFUSER
MODELLO 1/ MODEL 1				
<b>MTP.5451. 0 X Y. Z</b>	12,5W/230V LED	2650/2540	60°	trasparente/transparent
<b>MTP.5451. 1 X Y. Z</b>	12,5W/230V LED	2650/2540	60°	satinato/satin
MODELLO 2/ MODEL 2				
<b>MTP.5453. 1 X Y. Z</b>	12,5W/230V LED	2650/2540	13°	trasparente/transparent
<b>MTP.5453. 2 X Y. Z</b>	12,5W/230V LED	2650/2540	20°	trasparente/transparent
<b>MTP.5453. 3 X Y. Z</b>	12,5W/230V LED	2650/2540	38°	trasparente/transparent
MODELLO 3/ MODEL 3				
<b>MTP.5454. 1 X Y. Z</b>	18W/230V LED	1880/1750	15°	trasparente/transparent
<b>MTP.5454. 2 X Y. Z</b>	18W/230V LED	1880/1750	25°	trasparente/transparent
<b>MTP.5454. 3 X Y. Z</b>	18W/230V LED	1880/1750	38°	trasparente/transparent

## ACCESSORI / ACCESSORIES



**MTP.SP**  
Picchetto Inox.  
Inox Spike.



**MTP.AG**  
Schermo antiabbagliamento.  
Anti-glare screen.





# K I N



Apparecchio d'illuminazione orientabile per esterni. Il corpo ha un angolo di rotazione di 145°, permettendogli di essere utilizzato in molteplici soluzioni come porticati, facciate, spazi espositivi esterni e monumenti. Iconica la versione nero raggrinzante, disponibile anche in un'ampia gamma di altre finiture.

Adjustable exterior spotlight. The body has a rotation angle of 145°, allowing it to be used in a variety of solutions such as porches, facades, outdoor exhibition spaces and monuments. Iconic wrinkled black version, also available in a wide range of other finishes.



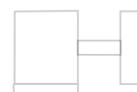

# NIK

Corpo in alluminio pressofuso, diffusore in vetro temperato. L'alimentazione a 230V ne permette una maggior semplicità dell'impianto rendendolo di facile installazione.

Die cast aluminium body, tempered glass diffuser. The 230V power permits an higher simplicity of the electrical system making it easy to be installed.

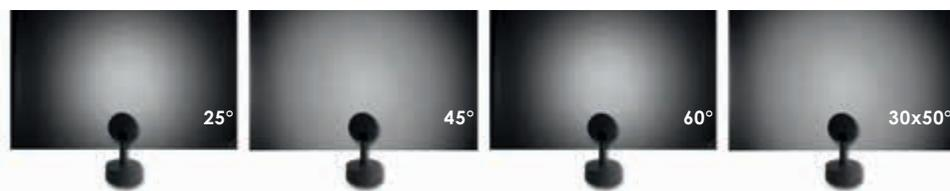

CE	IP66
LED	RG1
CRI 80/90	Driver on/off incl.
L80 B10	Mac Adam 3
50000H	



# NIK

**D.**  
25°  
2

45°  
3

30°x50°  
4

60°  
5

**X.**  
CRI80  
5

CRI90  
6

4000K  
7

3000K  
8

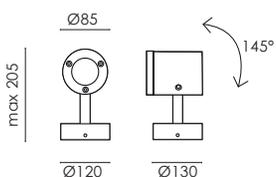

**Z.**  
COLOR

- antracite / anthracite - **06**
- bianco ragg. / rough white - **32**
- nero ragg. / rough black - **33**
- grigio chiaro / clear grey - **37**
- custom - **99**

COD. ON/OFF	W	K	LM	FASCIO / BEAM
<b>NIK.4443. D X 7. Z</b>	20W/230V LED COB	4000 K	2840	25°/45°/30°x50°/60°
<b>NIK.4443. D X 8. Z</b>	20W/230V LED COB	3000 K	2710	25°/45°/30°x50°/60°
			GU 10	

**NIK.4563.000. Z** 20W/230V LED Gu10 lampada esclusa / lamp excluded

## ACCESSORI / ACCESSORIES



**NIK.SP**  
Picchetto Inox.  
Inox Spike.



**AAA.CN3**  
Connettore IP68, 3vie.  
IP68 waterproof connector, 3way.



**AAA.CN4**  
Connettore IP68, 4vie.  
IP68 waterproof connector, 4way.



# TITAN

Apparecchio orientabile per esterni dal tipico design lineare e funzionale, interamente in acciaio INOX. Il riflettore speculare sfaccettato per diversi fasci luminosi, ne permette la versatilità di utilizzo, sia per illuminazioni puntuali di monumenti e facciate, sia per giardini e architetture esterne.

Adjustable outdoor light fitting with a typical linear and functional design, entirely made of stainless steel. The faceted specular reflector for different light beams makes it versatile to use, both for spot lighting of monuments and facades and for gardens and outdoor architecture.





## TITAN

Proiettore orientabile per esterni. Corpo e anello in acciaio inossidabile AISI 304L. Vetro trasparente. Driver incluso.

Adjustable projector for outdoor. Body and ring in stainless steel AISI 304L. Transparent glass. Driver included.

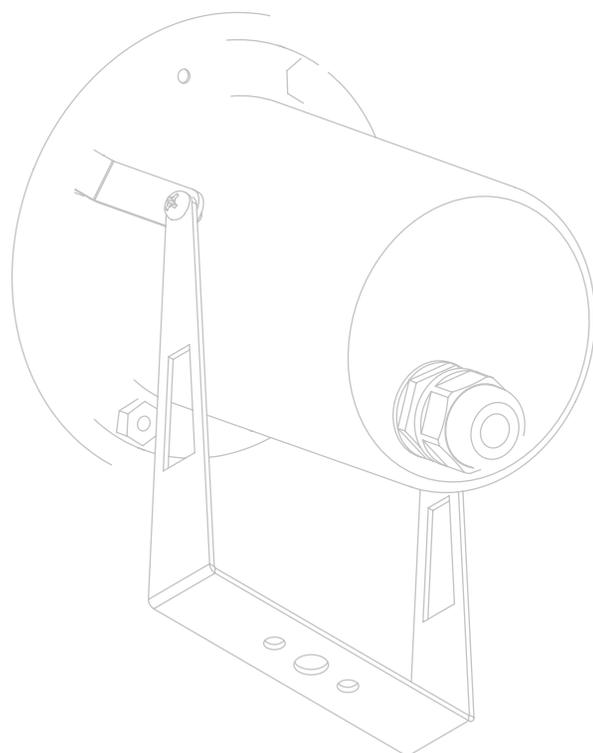

CE	IP65
LED	RG1
CRI 80/90	Driver on/off incl.
L80 B10	Mac Adam 3
50000H	



# TITAN

D.  
36°  
1

24°  
2

12°  
3

X.  
CRI80  
5

CRI90  
6

4000K  
7

3000K  
8

2700K  
9

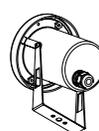
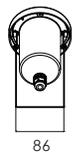
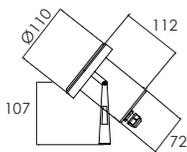

COD. ON/OFF

W

K

LM

FASCIO / BEAM

**NTI.4702. D X 7**

9W/230V LED

4000

890

36°/24°/12°

**NTI.4702. D X 8**

9W/230V LED

3000

840

36°/24°/12°

**NTI.4702. D X 9**

9W/230V LED

2700

770

36°/24°/12°

## ACCESSORI / ACCESSORIES



**NTI.SP**  
Picchetto Inox.  
Inox Spike.



**AAA.CN3**  
Connettore IP68, 3vie.  
IP68 waterproof connector, 3way.



**AAA.CN4**  
Connettore IP68, 4vie.  
IP68 waterproof connector, 4way.





# RAGGIO SPOT



Raggio Spot è un proiettore orientabile per esterno dalle dimensioni ridotte e dalle linee essenziali e discrete. Disponibile in 3 fasci di luce, garantisce versatilità e precisione nell'illuminazione di facciate, balconi ed architetture esterne. Può essere inoltre la soluzione ideale per l'illuminazione di spazi verdi quali giardini, aiuole e piantumazioni.

Raggio Spot is an adjustable outdoor projector with small dimensions and essential, discreet lines. Available in three light beams, it guarantees versatility and precision in the illumination of facades, balconies and outdoor architecture. It can also be the ideal solution for lighting green spaces such as gardens, flowerbeds and plantings.



## RAGGIO SPOT

Corpo e anello di chiusura in lega di alluminio sottoposti a pre-trattamento di anodizzazione galvanica. Grado di protezione IP65. Schermo di protezione in vetro trasparente temperato. Equipaggiato con un LED di colore bianco 4000K o 3000K da alimentare direttamente a 230V. Potenza 7W. Fornito completo di cavo di collegamento H05RN-F 3x1mm<sup>2</sup>. Staffa inclusa.

Body and closing ring in aluminum alloy with galvanic anodizing pre-treatment. IP65 protection degree. Protection shield made of transparent tempered glass. Equipped with one LED in 4000K or 3000K color to be supplied at 230V. Power 7W. Supplied with H05RN-F 3x1mm<sup>2</sup> connecting cable. Bracket included.

Scopri anche / look at:

### RAGGIO FAMILY

pag. 142

Incassi a pavimento

Buried & uplights



CE	IP65
LED	RG1
CRI 80	Driver on/off incl.
L80 B10	Mac Adam 3
50000H	



# RAGGIO SPOT

<b>Z.</b>	antracite / anthracite - <b>06</b>	
<b>COLOR</b>	grigio chiaro opaco/clear matt grey - <b>37</b>	
	custom - <b>99</b>	

**D.**  
18°  
1

36°  
2

60°  
3

CR180  
5

4000K  
7

3000K  
8

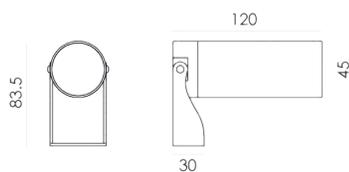

COD. ON/OFF	W	K	LM	FASCIO / BEAM
<b>LAA.5107. D 5 7. Z</b>	7W/230V LED	4000	840	18°/36°/60°
<b>LAA.5107. D 5 8. Z</b>	7W/230V LED	3000	793	18°/36°/60°

## ACCESSORI / ACCESSORIES



**LAA.SP**  
Picchetto Inox.  
Inox Spike.



**AAA.CN3**  
Connettore IP68, 3vie.  
IP68 waterproof connector, 3way.



**LAA.AS**  
Asta h.300mm con picchetto.  
Rod h.300mm with spike.



**AAA.CN4**  
Connettore IP68, 4vie.  
IP68 waterproof connector, 4way.



# TEBE



Un nuovo elemento arricchisce la collezione di apparecchi in acciaio INOX in casa CIVIC. Pensato per illuminare verso il basso con una distribuzione uniforme della luce, TEBE è la soluzione perfetta per giardini ed esterni residenziali di ogni tipo. TEBE viene proposto come elemento completo di due diverse altezze o come lampada da montare su qualsiasi palo Ø 60 mm.

A new element enriches the CIVIC collection of stainless steel fittings. Designed for a uniform downward light distribution, TEBE is the perfect solution for gardens and residential exteriors in general. TEBE is proposed complete with pole of different heights or as element to be mounted on any 60 mm pole.



## TEBE

Corpo interamente in acciaio inox AISI 304. Grado di protezione IP65. Schermo di protezione in policarbonato satinato infrangibile. Guarnizione in gomma al silicone. Equipaggiato con LED di colore bianco 4000K o 3000K. Potenze da 13W a 17W. Fornito completo di driver integrato nella struttura e di cavo di collegamento H05RN-F 3x1mm.

Structure and closing ring made of AISI 304 stainless steel. IP67 protection degree. Protection shield made in satin polycarbonate. Silicone rubber gasket. Equipped with white LED 4000K or 3000K. Powers from 13W to 17W. Supplied complete with built in driver and H05RN-F 3x1mm connection cable.

CE	IP65
LED	RG0
CRI 80	Driver on/off incl.
L80 B10	Mac Adam 3
50000H	

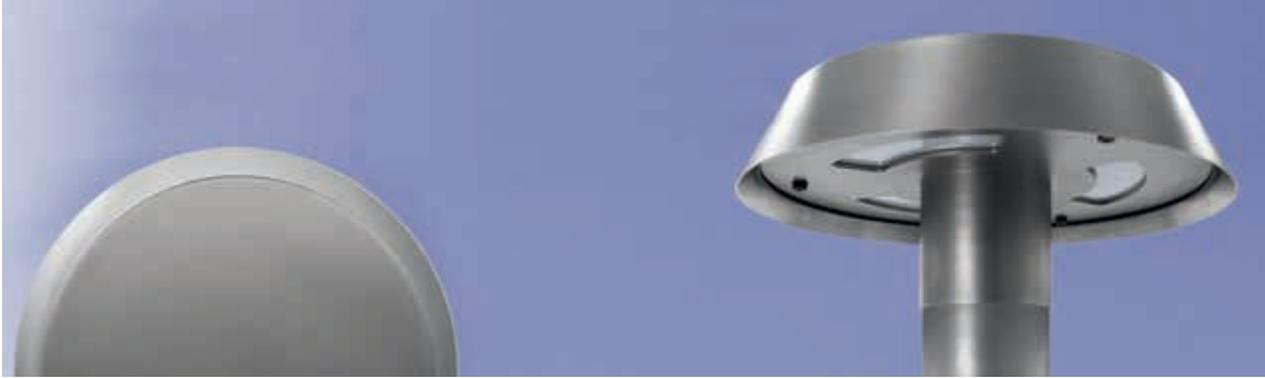

# TEBE

Z.  
COLOR

- grigio antracite / anthracite grey - **06**
- bianco raggrinzante / rough white - **32**
- grigio chiaro opaco / clear matte grey - **37**
- verde salvia / sage - **53**
- giallo / yellow - **54**
- Custom - **99**

- CRIB0 **5**
- Y. **4000K** **7**
- 3000K** **8**
- 2700K** **9**

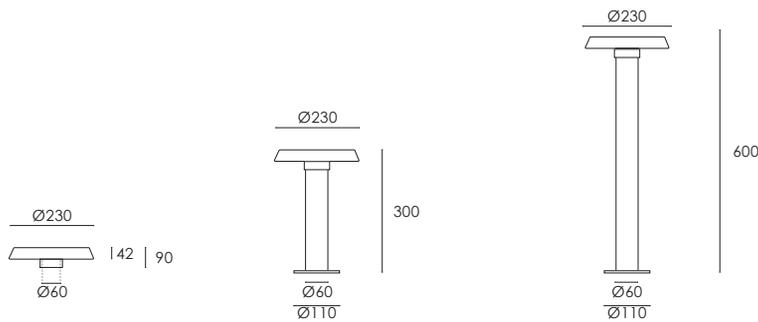

COD.ON/OFF	H.MM	W	LM	PALO/POLE
SOLO TESTA/ ONLY HEAD				
<b>MTY.7001.0 5 Y. Z</b>		13W/230V LED	2100/2000	palo escluso/pole excluded
<b>MTY.7002.0 5 Y. Z</b>		17W/230V LED	2700/2550	palo escluso/pole excluded
300 MM				
<b>MTY.7031.0 5 Y. Z</b>	300	13W/230V LED	2100/2000	palo incluso/pole included
<b>MTY.7032.0 5 Y. Z</b>	300	17W/230V LED	2700/2550	palo incluso/pole included
600 MM				
<b>MTY.7061.0 5 Y. Z</b>	600	13W/230V LED	2100/2000	palo incluso/pole included
<b>MTY.7062.0 5 Y. Z</b>	600	17W/230V LED	2700/2550	palo incluso/pole included

## ACCESSORI / ACCESSORIES



**MTY.TF**  
Tirafondi per muratura.  
Pole fixing bolts.





# MINI A P O L L O P A L E T T O



Paletto per l'illuminazione di giardini, passaggi, aree residenziali. Le sue due altezze e la possibilità della doppia illuminazione lo rendono adatto a svariati ambienti e situazioni, potendo creare differenti soluzioni luminose. La lavorazione realizzata sul vetro ne permette il perfetto posizionamento a filo della cornice.

Bollard for lighting gardens, walkways and residential areas. Its two heights and the possibility of double lighting make it suitable for a variety of environments and situations, creating different lighting solutions. The processing carried out on the glass allows it to be perfectly positioned flush with the frame.



## MINI APOLLO PALETTO

La struttura è in alluminio estruso verniciato a polveri, il diffusore in vetro temperato. Disponibile in due altezze: 200 mm e 500 mm per un' illuminazione bi e mono direzionale.

The structure is in powder coated extruded aluminium, tempered glass diffuser. Available in 2 heights: 200mm and 500mm to have a single and bidirectional light emission.



Scopri anche / look at:

**Apollo & Mini Apollo**

pag. 30

Esterni a soffitto & parete  
Exterior wall & ceiling



CE	IP65
LED	RG1
CRI 80/90	Driver on/off incl.
L80 B10	Mac Adam 3
50000H	



# MINI APOLLO PALETTO

**Z.**  
COLOR

antracite/anthracite - 06   
 grigio chiaro opaco/clear matt grey - 37   
 custom -99 

**X.**  
CRI80  
5

CRI90  
6

**Y.**  
4000K  
7

3000K  
8

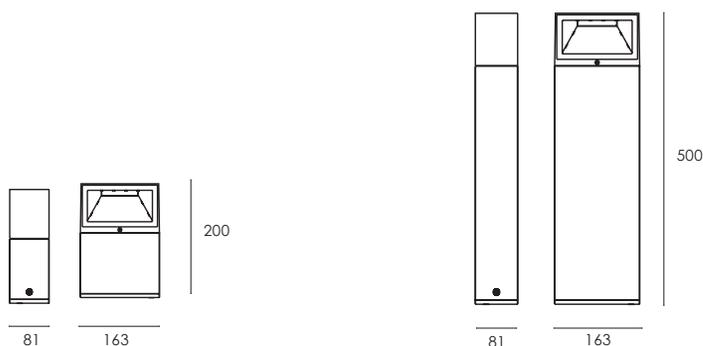

COD.ON/OFF	H.MM	W	LM	EMISSIONE / EMISSION
200 MM				
<b>MTA.5465.2 X Y. Z</b>	200	8x1.2W LED	752/680	bidirezionale/bi directional
<b>MTA.5466.2 X Y. Z</b>	200	8x1.2W LED	752/680	monodirezionale/mono directional
500 MM				
<b>MTA.5467.2 X Y. Z</b>	500	8x1.2W LED	752/680	bidirezionale/bi directional
<b>MTA.5468.2 X Y. Z</b>	500	8x1.2W LED	752/680	monodirezionale/mono directional

## ACCESSORI / ACCESSORIES



**MTA.TF**  
Tirafondi per muratura.  
Pole fixing bolts.





# INCASSI A PAVIMENTO

## Buried & uplights

# Outdoor



# CARRABILI DRIVEWAY



Sono gli incassi a terra storici di Civic. Le nuove fonti luminose e la nuova tecnologia produttiva mantengono questa collezione originale e al passo con i tempi. La famiglia è realizzata interamente in acciaio Inox offrendo maggior resistenza e durata nel tempo.

Civic's historic ground recessed range. The new sources and the new production technology, maintains this range up to date. The construction entirely in Stainless steel ensure reliability and quality along the time.

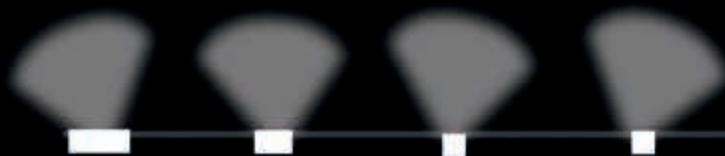

Carrabili





Era  
Diana



Perseo  
Zeus







## ZEUS

Corpo e anello di chiusura in acciaio inox AISI 304. Grado di protezione IP67. Schermo di protezione in vetro trasparente temperato di spessore 12mm con resistenza meccanica IK 10 per passaggio veicolare. Guarnizione in gomma al silicone. Riflettore fisso asimmetrico o orientabile. Equipaggiato con un LED di colore bianco 4000K o 3000K. Potenze da 17W a 24W. Fornito completo di driver integrato nella struttura e di cavo di collegamento H05RN-F 3x1mm<sup>2</sup>.

Structure and closing ring made of AISI 304 stainless steel. IP67 protection degree. Protection shield made of transparent tempered glass with 12mm thickness and IK 10 shock resistance for vehicle passage use. Silicone rubber gasket. Fixed, asymmetric or adjustable reflector. Equipped with one LED in 4000K or 3000K color temperature. Power from 17W up to 24W. Supplied with built-in driver and H05RN-F 3x1mm<sup>2</sup> connecting cable.



## PERSEO

Corpo e anello di chiusura in acciaio inox AISI 304. Grado di protezione IP67. Schermo di protezione in vetro trasparente temperato di spessore 12mm con resistenza meccanica IK 10 per passaggio veicolare. Guarnizione in gomma al silicone. Riflettore fisso asimmetrico o orientabile. Equipaggiato con un LED di colore bianco 4000K o 3000K. Potenza 17W. Fornito completo di driver integrato nella struttura e di cavo di collegamento H05RN-F 3x1mm<sup>2</sup>.

Structure and closing ring made of AISI 304 stainless steel. IP67 protection degree. Protection shield made of transparent tempered glass with 12mm thickness and IK 10 shock resistance for vehicle passage use. Silicone rubber gasket. Fixed, asymmetric or adjustable reflector. Equipped with one LED in 4000K or 3000K color temperature. Power 17W. Supplied with built-in driver and H05RN-F 3x1mm<sup>2</sup> connecting cable.

CE	IP67
LED	RG1
CRI 80/90	Driver on/off incl.
L80 B10	Driveover Carrabile
50000H	Mac Adam 3



# Z E U S

**D.**  
OPTIC  
38° 1

OPTIC  
20° 2

OPTIC  
13° 3

**X.**  
CRI80  
5

CRI90  
6

**Y.**  
4000K  
7

3000K  
8

FISSO / FIXED

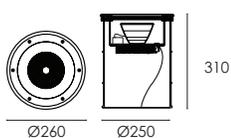

ORIENTABILE / ADJUSTABLE

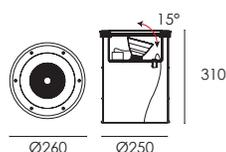

ASIMMETRICO / ASYMMETRIC

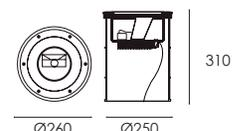

**COD. ON/OFF**

**D.MM**

**W**

**LM**

**DRIVER**

FISSO / FIXED

**JEZ.5580. D X Y**

Ø260

24W/230V LED

3710/3550

built-in/incorporato

ORIENTABILE / ADJUSTABLE

**JEZ.5581. D X Y**

Ø260

17W/230V LED

2700/2550

built-in/incorporato

ASIMMETRICO / ASYMMETRIC

**JEZ.5582. 1 X Y**

Ø260

24W/230V LED

3710/3550

built-in/incorporato

## ACCESSORI / ACCESSORIES



**JEZ.FG**  
Vetro sabbato  
Sanded glass.



**AAA.CN3**  
Connettore IP68, 3vie.  
IP68 waterproof connector, 3way.



**JEZ.FR2**  
Cornice quadrata  
Square ring.



**AAA.CN4**  
Connettore IP68, 4vie.  
IP68 waterproof connector, 4way.



CE	IP67
<b>LED</b>	<b>RG1</b>
CRI 80/90	Driver on/off incl.
L80 B10	Driveover Carrabile
50000H	Mac Adam 3
⏚	

# PERSEO

FISSO / FIXED

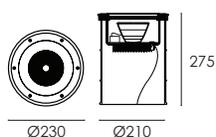

ORIENTABILE / ADJUSTABLE

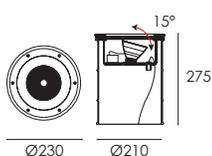

ASIMMETRICO / ASYMMETRIC

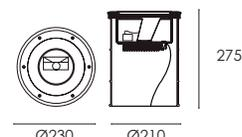

**D.**  
OPTIC  
38°  
1

OPTIC  
20°  
2

OPTIC  
13°  
3

**X.**  
CRI80  
5

CRI90  
6

**Y.**  
4000K  
7

3000K  
8

**COD. ON/OFF**

**D.MM**

**W**

**LM**

**DRIVER**

FISSO / FIXED

**JEP.5590. D X Y**

Ø230

17W/230V LED

2700/2550

built-in/incorporato

ORIENTABILE / ADJUSTABLE

**JEP.5591. D X Y**

Ø230

17W/230V LED

2700/2550

built-in/incorporato

ASIMMETRICO / ASYMMETRIC

**JEP.5592. D X Y**

Ø230

17W/230V LED

2700/2550

built-in/incorporato

## ACCESSORI / ACCESSORIES

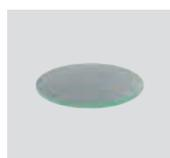

**JEP.FG**

Vetro sabbato  
Sanded glass.



**JEP.FR2**

Cornice quadrata  
Square ring.



**AAA.CN3**

Connettore IP68, 3vie.  
IP68 waterproof connector, 3way.



**AAA.CN4**

Connettore IP68, 4vie.  
IP68 waterproof connector, 4way.





## ERA

Corpo e anello di chiusura in acciaio inox AISI 304. Grado di protezione IP67. Schermo di protezione in vetro trasparente temperato di spessore 10mm con resistenza meccanica IK 10 per passaggio veicolare. Guarnizione in gomma al silicone. Equipaggiato con un LED di colore bianco 4000K o 3000K. Potenza da 13W. Fornito completo di driver integrato nella struttura e di cavo di collegamento H05RN-F 3x1mm<sup>2</sup>.

Structure and closing ring made of AISI 304 stainless steel. IP67 protection degree. Protection shield made of transparent tempered glass with 10mm thickness and IK 10 shock resistance for vehicle passage use. Silicone rubber gasket. Fixed reflector. Equipped with one LED in 4000K or 3000K color temperature. Power 13W. Supplied with built-in driver and H05RN-F 3x1mm<sup>2</sup> connecting cable.



## DIANA

Corpo e anello di chiusura in acciaio inox AISI 304. Grado di protezione IP67. Schermo di protezione in vetro trasparente temperato di spessore 10mm con resistenza meccanica IK 10 per passaggio veicolare. Guarnizione in gomma al silicone. Ottica fissa o orientabile. Equipaggiato con LED di colore bianco da 4000K o 3000K con potenza 9W o con portalampada GU10 o RGB 6W, fornito completo di driver integrato nella struttura e di cavo di collegamento H05RN-F 3x1mm<sup>2</sup>. Disponibile anche nella versione RGB con potenza 6W.

Structure and closing ring made of AISI 304 stainless steel. IP67 protection degree. Protection shield made of transparent tempered glass with 10mm thickness and IK 10 shock resistance for vehicle passage use. Silicone rubber gasket. Fixed or adjustable optic. Equipped with one LED in 4000K or 3000K color temperature power 9W or with GU10 lampholder or 6W RGBc, supplied with built-in driver and H05RN-F 3x1mm<sup>2</sup> connecting cable. Also available in RGB version power 6W.



CE	IP67
LED	RG1
CRI 80/90	Driver on/off incl.
L80 B10	Driveover Carrabile
50000H	Mac Adam 3
⏚	



# ERA

**D.**  
OPTIC  
45° 1

OPTIC  
24° 2

OPTIC  
10° 3

**X.**  
CRI80  
5

CRI90  
6

**Y.**  
4000K  
7

3000K  
8

FISSO / FIXED

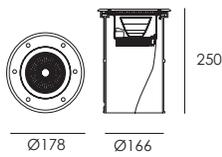

COD. ON/OFF	D.MM	W	LM	DRIVER
		FISSO / FIXED		
<b>JEL.5540. D X Y</b>	Ø178	13W/230V LED	2100/2000	built-in/incorporato

## ACCESSORI / ACCESSORIES



**JEL.FG**  
Vetro sabbato  
Sanded glass.



**JEL.FR2**  
Cornice quadrata  
Square ring.



**AAA.CN3**  
Connettore IP68, 3vie.  
IP68 waterproof connector, 3way.



**AAA.CN4**  
Connettore IP68, 4vie.  
IP68 waterproof connector, 4way.





CE	IP67
LED	RG1
CRI 80/90	Driver on/off incl.
L80 B10	Driveover Carrabile
50000H	Mac Adam 3
⏚	

# DIANA

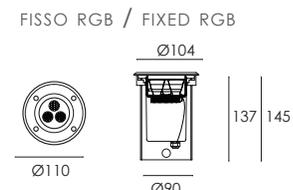
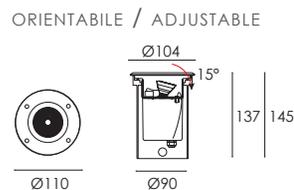
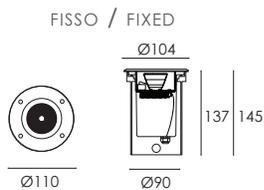

- D. OPTIC 36° 1
- OPTIC 24° 2
- OPTIC 12° 3
- X. CRI80 5
- CRI90 6
- Y. 4000K 7
- 3000K 8
- 2700K 9

COD. ON/OFF	D.MM	W	LM	DRIVER	
FISSO / FIXED					
JEO.5502. D X Y	Ø110	9W/230V LED	890/840/770	built-in/incorporato	
JEO.35FGUB	Ø110	20W/230V GU10 lamp. esclusa/lamp excluded			
ORIENTABILE / ADJUSTABLE					
JEO.5503. D X Y	Ø110	9W/230V LED	890/840/770	built-in/incorporato	
JEO.35MGUB	Ø110	20W/230V GU10 lamp. esclusa/lamp excluded			
COD. ON/OFF	D.MM	W	LM	FASCIO / BEAM	DRIVER
FISSO / FIXED — RGB					
JEO.5502.299	Ø110	6W/24V LED RGB	420	25°	excluded/escluso

## ACCESSORI / ACCESSORIES



**JEO.C1**  
Calottina a 1 finestra.  
1 window dome.



**JEO.FG**  
Vetro sabbaiato  
Sanded glass.



**JEO.FR2**  
Cornice quadrata  
Square ring.



**JEO.MS**  
Master JEO RGB.



**JEO.SL**  
Slave JEO RGB.



**AAA.CN3**  
Connettore IP68, 3vie.  
IP68 waterproof connector, 3way.



**AAA.CN4**  
Connettore IP68, 4vie.  
IP68 waterproof connector, 4way.

# CALPESTABILI WALKABLE



Serie di incassi a terra di Civic ispirati all'analogica serie carrabile. L'abbinamento di estetica e performance rendono questa collezione particolarmente adatta ove la fonte luminosa diventi elemento di design. La famiglia è realizzata interamente in acciaio Inox offrendo resistenza e durata nel tempo.

This family of ground recessed fittings is inspired by the similar drive over-one. Performance and aesthetics makes this range suitable where the light source needs to be installed in a design contest. The construction entirely in Stainless steel ensure reliability and quality along the time.

Eric  
David  
Zante



Calpestabili



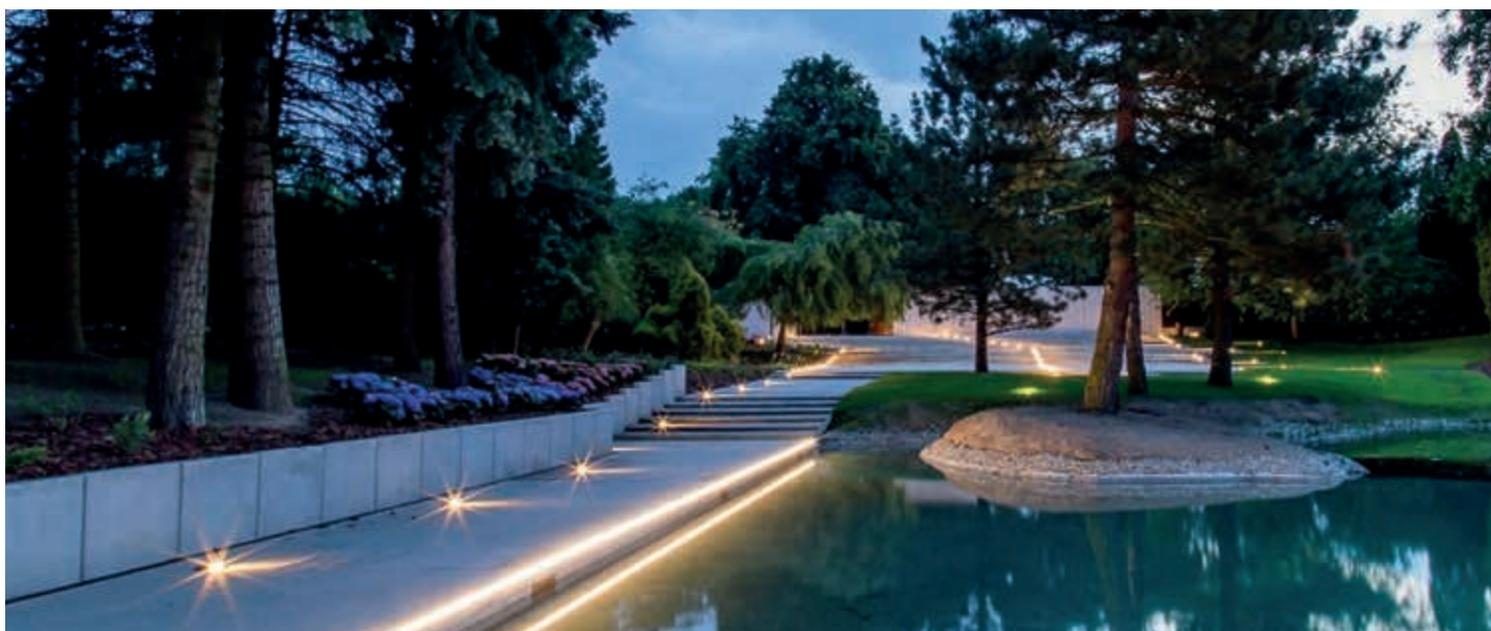

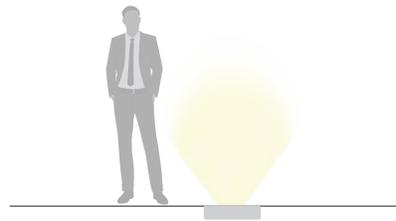

## ZANTE

Corpo e anello di chiusura in acciaio inox AISI 304. Grado di protezione IP67. Schermo di protezione in vetro trasparente temperato di spessore 12mm con resistenza meccanica IK 10 per passaggio pedonale. Guarnizione in gomma al silicone. Riflettore fisso asimmetrico o orientabile. Equipaggiato con un LED di colore bianco 4000K o 3000K. Potenze da 17W a 24W. Fornito completo di driver integrato nella struttura e di cavo di collegamento H05RN-F 3x1mm<sup>2</sup>.

Structure and closing ring made of AISI 304 stainless steel. IP67 protection degree. Protection shield made of transparent tempered glass with 12mm thickness and IK 10 shock resistance for walk-over use. Silicone rubber gasket. Fixed, asymmetric or adjustable reflector. Equipped with one LED in 4000K or 3000K color temperature. Power from 17W up to 24W. Supplied with built-in driver and H05RN-F 3x1mm<sup>2</sup> connecting cable.

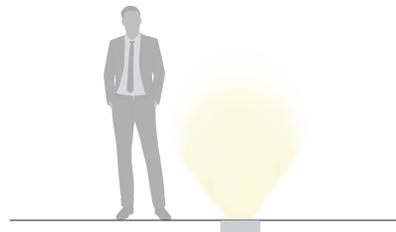

## ERIC

Corpo e anello di chiusura in acciaio inox AISI 304. Grado di protezione IP67. Schermo di protezione in vetro trasparente temperato di spessore 10mm con resistenza meccanica IK 10 per passaggio pedonale. Guarnizione in gomma al silicone. Equipaggiato con un LED di colore bianco 4000K o 3000K. Potenza 13W. Fornito completo di driver integrato nella struttura e di cavo di collegamento H05RN-F 3x1mm<sup>2</sup>.

Structure and closing ring made of AISI 304 stainless steel. IP67 protection degree. Protection shield made of transparent tempered glass with 10mm thickness and IK 10 shock resistance for walk-over use. Silicone rubber gasket. Fixed reflector. Equipped with one LED in 4000K or 3000K color temperature. Power 13W. Supplied with built-in driver and H05RN-F 3x1mm<sup>2</sup> connecting cable.

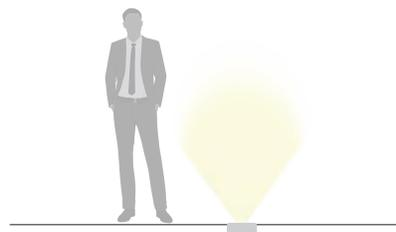

## DAVID

Corpo e anello di chiusura in acciaio inox AISI 304. Grado di protezione IP67. Schermo di protezione in vetro trasparente temperato di spessore 10mm con resistenza meccanica IK 10 per passaggio pedonale. Guarnizione in gomma al silicone. Ottica fissa o orientabile. Equipaggiato con LED di colore bianco 4000K o 3000K potenza 9W o con portalampada GU10 o RGB 6W, fornito completo di driver integrato nella struttura e di cavo di collegamento H05RN-F 3x1mm<sup>2</sup>. Disponibile anche nella versione RGB con potenza 6W.

Structure and closing ring made of AISI 304 stainless steel. IP67 protection degree. Protection shield made of transparent tempered glass with 10mm thickness and IK 10 shock resistance for walk-over use. Silicone rubber gasket. Fixed or adjustable optic. Equipped with one LED in 4000K or 3000K color temperature power 9W or with GU10 lampholder or 6W RGB, supplied with built-in driver and H05RN-F 3x1mm<sup>2</sup> connecting cable. Also available in RGB version power 6W.



CE	IP67
LED	RG1
CRI 80/90	Driver on/off incl.
L80 B10	Mac Adam 3
50000H	



# ZANTE

D.  
OPTIC  
38°  
1

OPTIC  
20°  
2

OPTIC  
13°  
3

X.  
CRI80  
5

CRI90  
6

Y.  
4000K  
7

3000K  
8

FISSO / FIXED

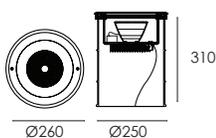

ORIENTABILE / ADJUSTABLE

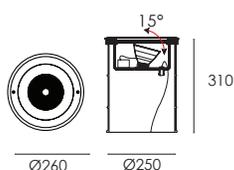

ASIMMETRICO / ASYMMETRIC

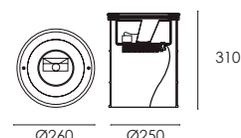

COD. ON/OFF

D.MM

W

LM

DRIVER

		FISSO / FIXED		
ZNT.6580. D X Y	Ø260	24W/230V LED	3710/3550	built-in/incorporato
		ORIENTABILE / ADJUSTABLE		
ZNT.6581. D X Y	Ø260	17W/230V LED	2700/2550	built-in/incorporato
		ASIMMETRICO / ASYMMETRIC		
ZNT.6582. 1 X Y	Ø260	24W/230V LED	3710/3550	built-in/incorporato

## ACCESSORI / ACCESSORIES



**ZNT.FG**  
Vetro sabbato  
Sanded glass.



**AAA.CN3**  
Connettore IP68, 3vie.  
IP68 waterproof connector, 3way.



**AAA.CN4**  
Connettore IP68, 4vie.  
IP68 waterproof connector, 4way.



CE	IP67
LED	RG1
CRI 80/90	Driver on/off incl.
L80 B10	Mac Adam 3
50000H	⚡

# ERIC

FISSO / FIXED

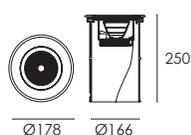

COD. ON/OFF	D.MM	W	LM	DRIVER
DEL.6540. D X Y	Ø178	13W/230V LED	2100/2000	built-in/incorporato

D.  
OPTIC  
45°  
1

OPTIC  
24°  
2

OPTIC  
10°  
3

X.  
CRI80  
5

CRI90  
6

Y.  
4000K  
7

3000K  
8

## ACCESSORI / ACCESSORIES



**DEL.FG**  
Vetro sabbato  
Sanded glass.



**AAA.CN3**  
Connettore IP68, 3vie.  
IP68 waterproof connector, 3way.



**AAA.CN4**  
Connettore IP68, 4vie.  
IP68 waterproof connector, 4way.

CE	IP67
LED	RG1
CRI 80/90	Driver on/off incl.
L80 B10	Mac Adam 3
50000H	



# DAVID

**D.**  
OPTIC  
36° 1

OPTIC  
24° 2

OPTIC  
12° 3

**X.**  
CRI80  
5

CRI90  
6

**Y.**  
4000K  
7

3000K  
8

2700K  
9

FISSO / FIXED

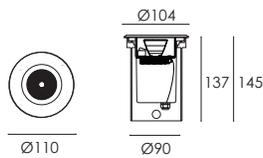

ORIENTABILE / ADJUSTABLE

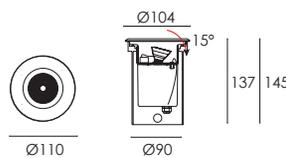

FISSO RGB / FIXED RGB

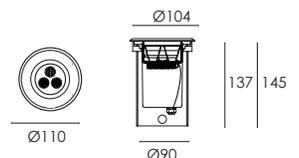

COD. ON/OFF	D.MM	W	LM	DRIVER	
FISSO / FIXED					
<b>DEO.6502. D X Y</b>	Ø110	9W/230V LED	890/840/770	built-in/incorporato	
<b>DEO.35FGU</b>	Ø110	20W/230V GU10 lamp. esclusa/lamp excluded			
ORIENTABILE / ADJUSTABLE					
<b>DEO.6503. D X Y</b>	Ø110	9W/230V LED	890/840/770	built-in/incorporato	
<b>DEO.35MGU</b>	Ø110	20W/230V GU10 lamp. esclusa/lamp excluded			
COD. ON/OFF	D.MM	W	LM	FASCIO/BEAM	DRIVER
FISSO / FIXED — RGB					
<b>DEO.6502.299</b>	Ø110	6W/24V LED	420	25°	excluded/escluso

## ACCESSORI / ACCESSORIES



**DEO.FG**  
Vetro sabbato  
Sanded glass.



**AAA.CN3**  
Connettore IP68, 3vie.  
IP68 waterproof connector, 3way.



**DEO.MS**  
Master DEO RGB.



**AAA.CN4**  
Connettore IP68, 4vie.  
IP68 waterproof connector, 4way.

**DEO.SL**  
Slave DEO RGB.





# BOSS



Boss è un proiettore da esterno con corpo impermeabile alla pioggia e alle intemperie. Il suo design funzionale ed accattivante impedisce all'acqua e ad altro materiale di depositarsi sulla sommità dell'apparecchio.

Grazie alla sua orientabilità, ampia gamma di ottiche e alta prestazione, Boss è ideale per applicazioni in molti spazi esterni come giardini, porticati, dehors e spazi domestici.

Boss is an outdoor spotlight with a rain- and weatherproof housing. Its functional and attractive design prevents water and other material from settling on top of the product.

Thanks to its adjustability, wide range of optics and high performance, Boss is ideal for applications in many outdoor spaces such as gardens, porches, patios and domestic spaces.



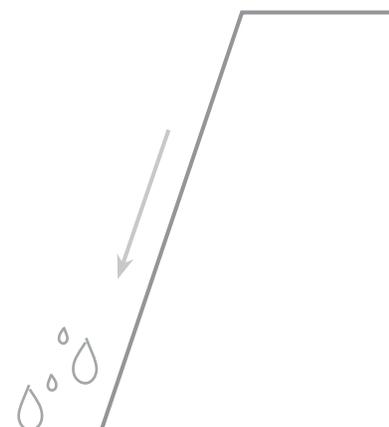

## BOSS

Struttura e anello di chiusura orientabile in acciaio inox, vetro temperato infrangibile da 8 mm di spessore. Disponibile nelle versioni con ottica fissa LED e adatta ad ospitare lampade Gu10. L'anello di chiusura e la viteria sono in acciaio inox AISI 304L.

Body and orientable closure ring in stainless steel, tempered and shatterproof glass 8 mm thick. Available in fixed LED and Gu10 versions. The closing frame and screws are in stainless steel AISI 304L.

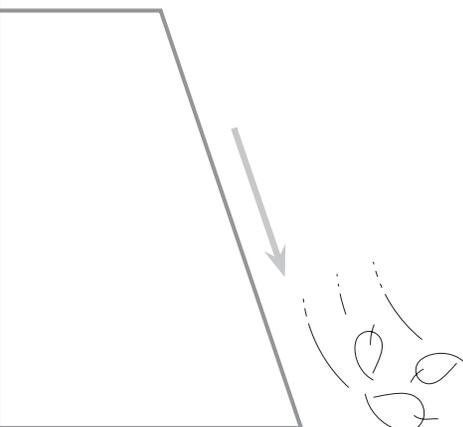

CE	IP65
<b>LED</b>	<b>RG1</b>
CRI 80/90	Driver on/off incl.
L80 B10	Mac Adam 3
50000H	



# BOSS

**D.**  
OPTIC  
36° 1

OPTIC  
24° 2

OPTIC  
12° 3

**X.**  
CRI80  
5

CRI90  
6

**Y.**  
4000K  
7

3000K  
8

2700K  
9

FISSO / FIXED

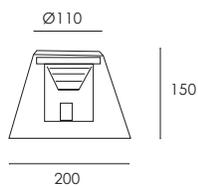

ORIENTABILE / ADJUSTABLE

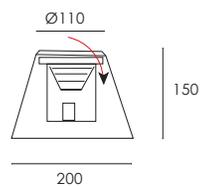

**COD. ON/OFF**

**D.MM**

**W**

**LM**

**DRIVER**

		FISSO / FIXED		
<b>BEO.7502 . D X Y</b>	Ø110	9W/230V LED	890/840/770	built-in/incorporato
<b>BEO.35FGU</b>	Ø110	20W/230V GU10 lamp. esclusa/lamp excluded		
		ORIENTABILE / ADJUSTABLE		
<b>BEO.7503 . D X Y</b>	Ø110	9W/230V LED	890/840/770	built-in/incorporato
<b>BEO.35MGU</b>	Ø110	20W/230V GU10 lamp. esclusa/lamp excluded		

## ACCESSORI / ACCESSORIES



**BEO.FG**  
Vetro sabbato  
Sanded glass.



**AAA.CN3**  
Connettore IP68, 3vie.  
IP68 waterproof connector, 3way.



**AAA.CN4**  
Connettore IP68, 4vie.  
IP68 waterproof connector, 4way.



# RAGGIO



Raggio è la famiglia "minimal" della gamma di prodotti da esterno Civic, caratterizzata da forme arrotondate e design essenziale. Non solo l'estetica dell'apparecchio, ma anche i coni e i tagli radenti di luce prodotti risultano di grande effetto. Raggio viene offerto in tre versioni per soddisfare le più diverse esigenze di illuminazione sia residenziale che architettonale.

Raggio is the "minimal" choice of the Civic outdoor range, characterized by shaped forms and essential design. Not only the aesthetics of the luminaire, but also the cones and grazing cuts of light produced are highly impressive. Raggio is offered in three different versions to meet the most different both residential and architectural lighting needs.

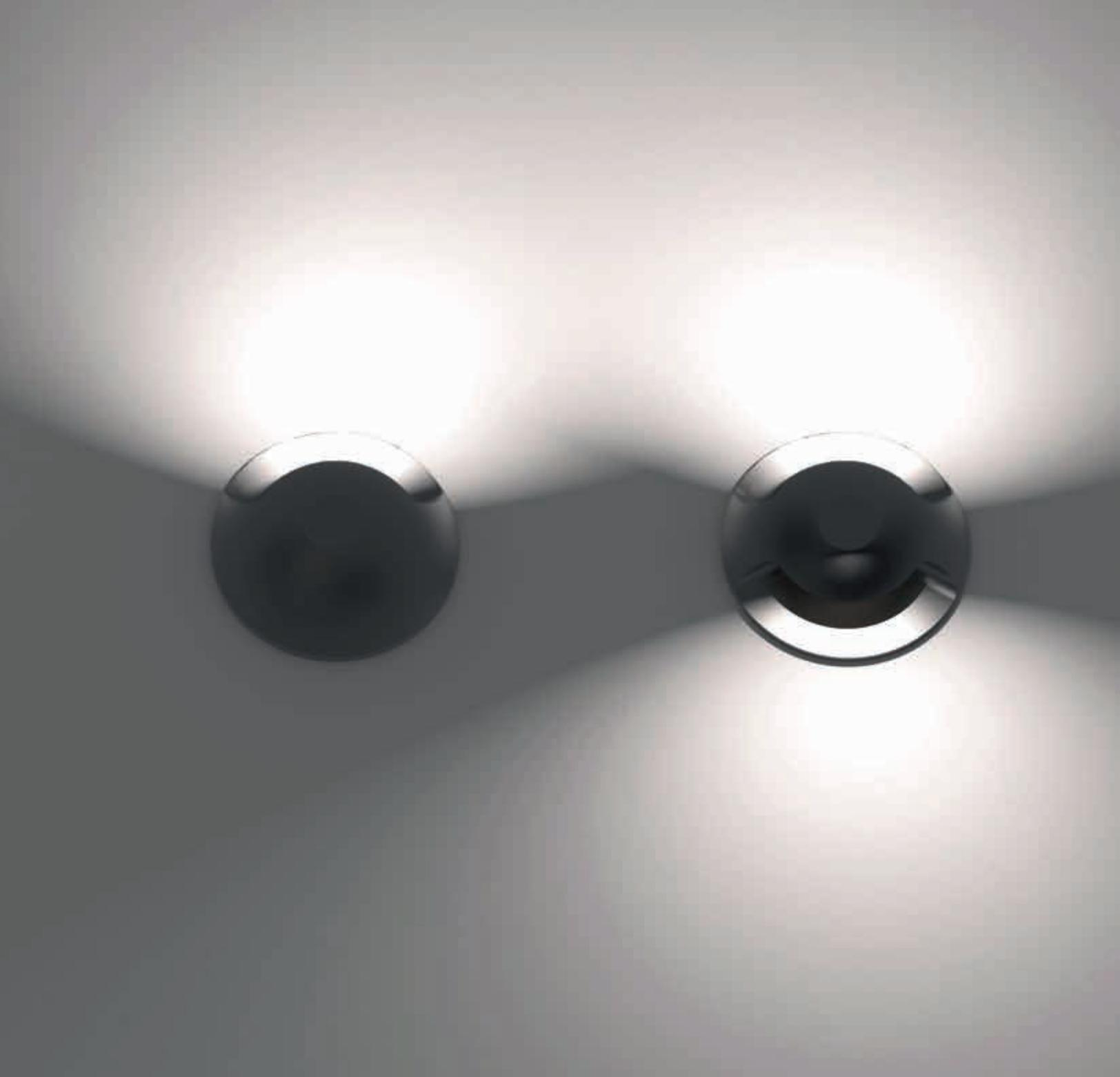

*Scopri anche / look at:*

## Raggio Spot

pag. 106

Paletti & proiettori

Poles & bollards









## RAGGIO SIDE

Corpo e anello di chiusura in lega di alluminio sottoposti a pre-trattamento di anodizzazione galvanica. Grado di protezione IP67. Calotta pressofusa in lega di alluminio, vetro temperato sagomato per una ottimale diffusione luminosa. Equipaggiato con un LED di colore bianco 4000K o 3000K da alimentare con trasformatore in corrente costante da cablare in serie. Potenze da 1.2W a 2.4W. Fornito completo di cavo di collegamento H05RN-F 2x1mm<sup>2</sup>.

Body and closing ring in aluminum alloy with galvanic anodizing pre-treatment. IP67 protection degree. Die cast aluminum cover, Protection shield made of shaped tempered glass. IK 10 shock resistance for vehicle passage use. Equipped with one LED in 4000K or 3000K color to be supplied with constant current driver (serial connection). Power from 1.2W up to 2.4W. Supplied with H05RN-F 2x1mm<sup>2</sup> connecting cable.



## RAGGIO UP

Corpo e anello di chiusura in lega di alluminio sottoposti a pre-trattamento di anodizzazione galvanica. Grado di protezione IP67. Schermo di protezione in vetro trasparente temperato di spessore 10mm con resistenza meccanica IK 10 per passaggio veicolare. Equipaggiato con un LED di colore bianco 4000K o 3000K da alimentare con trasformatore in corrente costante da cablare in serie. Potenze da 1.2W a 2.4W. Fornito completo di cavo di collegamento H05RN-F 2x1mm<sup>2</sup>.

Body and closing ring in aluminum alloy with galvanic anodizing pre-treatment. IP67 protection degree. Protection shield made of transparent tempered glass with 10mm thickness and IK 10 shock resistance for vehicle passage use. Equipped with one LED in 4000K or 3000K color to be supplied with constant current driver (serial connection). Power from 1.2W up to 2.4W. Supplied with H05RN-F 2x1mm<sup>2</sup> connecting cable.

CE	IP67
LED	RG1
CRI 80	Mac Adam 3
L80 B10	
50000H	



# RAGGIO SIDE

**Z.** grigio metallizzato / metallic grey - 50 

- CRI80**  
5
- 4000K**  
7
- 3000K**  
8

MONODIREZIONALE / MONO DIRECTIONAL

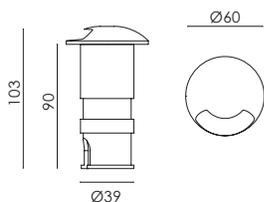

BIDIREZIONALE / BI DIRECTIONAL

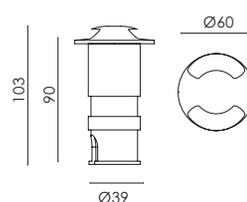

COD. ON/OFF	D.MM	W	K	RING	DRIVER
MONODIREZIONALE / MONO DIRECTIONAL					
<b>LAA.5101.8 5 7. Z</b>	Ø60	1x1.2W/2.4 350/700mA	4000	1 window	escluso/excluded
<b>LAA.5101.8 5 8. Z</b>	Ø60	1x1.2W/2.4 350/700mA	3000	1 window	escluso/excluded
BIDIREZIONALE / BI DIRECTIONAL					
<b>LAA.5101.9 5 7. Z</b>	Ø60	1x1.2W/2.4 350/700mA	4000	2 windows	escluso/excluded
<b>LAA.5101.9 5 8. Z</b>	Ø60	1x1.2W/2.4 350/700mA	3000	2 windows	escluso/excluded

## ACCESSORI / ACCESSORIES



**AAA.TRSL00**  
Driver IP20 3W/350mA.



**AAA.TRSL41**  
Driver IP20 6W/500mA.



**AAA.TRSL05**  
Driver IP20 19W 350/700 mA.



**AAA.TRSL45**  
Driver IP20 20W/500mA.



CE	IP67
LED	RG1
CRI 80	Mac Adam 3
L80 B10	
50000H	

50 - grigio metallizzato / metallic grey

Z. COLOR

# RAGGIO UP

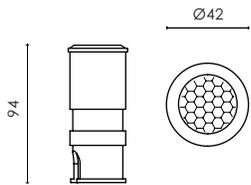

COD. ON/OFF	D.MM	W	K	DRIVER
LAA.5101.D 5 7. Z	Ø42	1x1.2W/2.4 350/700mA	4000	escluso/excluded
LAA.5101.D 5 8. Z	Ø42	1x1.2W/2.4 350/700mA	3000	escluso/excluded

D. OPTIC 15° 1

OPTIC 60° 4

CRI80 5

4000K 7

3000K 8

## ACCESSORI / ACCESSORIES



**AAA.TRSL00**  
Driver IP20 3W/350mA.

**AAA.TRSL30**  
Driver IP20 3W/700mA.



**AAA.TRSL05**  
Driver IP20 19W 350/700 mA.



**AAA.TRSL41**  
Driver IP20 6W/500mA.



**AAA.TRSL45**  
Driver IP20 20W/500mA.

Indoor INTERNI

INTERNI indoor

INTERNI INDOOR

INDOOR INTER

**INDOOR** INDOOR

INTERNI INTERNI

INDOOR intern

INTERNI INDOOR

I INDOOR INTER

r **INTERNI** Indoo

OR INDOOR IN

RNI Indoor INTER

OR **INTERNI** IND

NI INDOOR INTER

ni Indoor INTERN

OR INTERNI inter





**Indoor**

# MINU - R



Minu-R è una collezione di anelli decorativi luminosi a luce diretta o a luce interna. Il design elegante e leggero è di grande impatto scenico ed è ideale per uffici, contesti residenziali e commerciali.

Minu-R is a collection of decorative lighting rings with direct or internal light. It can offer such elegant and light design, with great scenic impact; it is the ideal choice for offices, residential and commercial environments.





Diffuser



Square

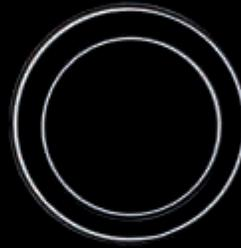

Perimeter



Lap





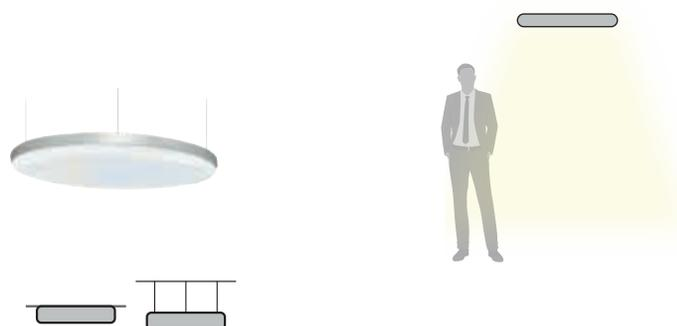

## MINU-R DIFFUSER

Profilo realizzato in lega di alluminio estruso curvato e verniciato a polveri con schermo di protezione in policarbonato. Tono bianco, 4000K o 3000K, Potenze da 60W/560mm a 198W/1120mm. Accessori per la sospensione da ordinare separatamente. Alimentatore on-off o dimmerabile incluso.

Structure in powder coated curved extrusion of aluminium alloy with opal diffuser. 4000K or 3000K white tone. Powers from 60W/560mm up to 198W/1120mm. Suspension kit to be ordered separately. On-Off or dimmable driver included.

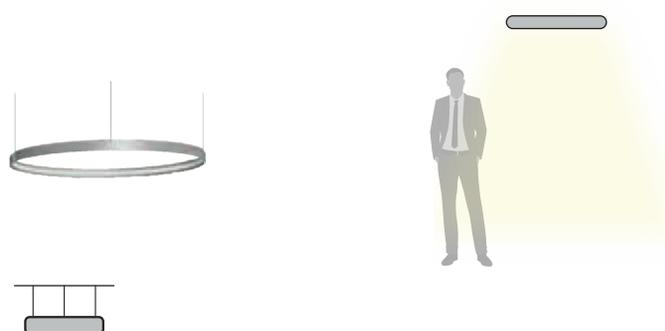

## MINU-R PERIMETER

Profilo realizzato in lega di alluminio estruso curvato e verniciato a polveri con schermo di protezione in policarbonato. Tono bianco, 4000K o 3000K. Potenze da 30W/560mm a 110W/1480mm. Accessori per la sospensione da ordinare separatamente. Alimentatore on-off o dimmerabile incluso nel rosone.

Structure in powder coated curved extrusion of aluminium alloy with opal diffuser. 4000K or 3000K white tone. Powers from 30W/560mm up to 110W/1480mm. Suspension kit to be ordered separately. On-Off or dimmable driver included in the ceiling cup.

CE	IP40
LED	RG1
CRI 80/90	Driver on/off incl.
L80 B10	Mac Adam 3
⚡	50000H



# MINU - R

## DIFFUSER

Z.  
COLOR

bianco raggrinzante/rough white -32   
 nero raggrinzante/rough black -33   
 custom -99

OPAL  
1

X.  
CRI80  
5

CRI90  
6

Y.  
4000K  
7

3000K  
8

DIM.  
1-10V  
A1

DALI  
A2

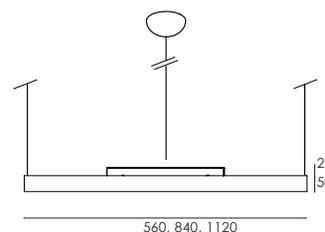
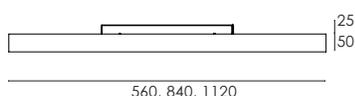
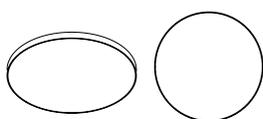

COD. ON/OFF	D.MM	W	LM
MNU.5625. 1 X Y. Z	560	60W/230V LED	8500/8300
MNU.5626. 1 X Y. Z	840	124W/230V LED	17000/16600
MNU.5627. 1 X Y. Z	1120	198W/230V LED	27300/27000

### ACCESSORI / ACCESSORIES



**MNU.SD1**  
 Kit di sospensione L.2000mm.  
 Suspension kit L.2000mm.



CE	IP40
LED	RG1
CRI 80/90	Mac Adam 3
L80 B10	50000H

- 32- bianco raggrinzante/rough white
- 33- nero raggrinzante/rough black
- 99- custom

**Z.**  
COLOR

# MINU - R

## PERIMETER

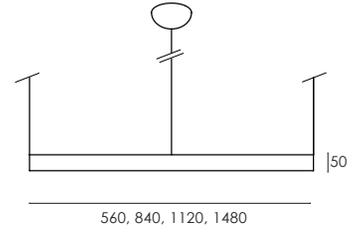
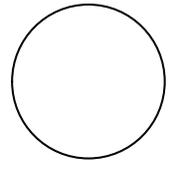
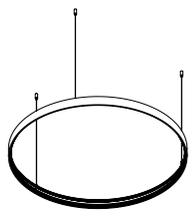

- OPAL 1
- X. CRI80 5
- CRI90 6
- Y. 4000K 7
- 3000K 8
- DIM. 1-10V A1
- DALI A2

COD. ON/OFF	D.MM	W	LM
MNU.5635. 1 X Y. Z	560	34W/230V LED	3010/2630
MNU.5636. 1 X Y. Z	840	51W/230V LED	4520/3950
MNU.5637. 1 X Y. Z	1120	67W/230V LED	6020/5270
MNU.5638. 1 X Y. Z	1480	90W/230V LED	9460/9100

### ACCESSORI / ACCESSORIES



**MNU.SP1**  
Kit di sospensione L.2000mm e driver 50W.  
Suspension kit L.2000mm and driver 50W.



**MNU.SP3**  
Kit di sospensione L.2000mm e driver 110W.  
Suspension kit L.2000mm and driver 110W.



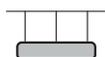
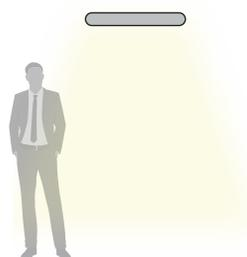

## MINU-R SQUARE

Profilo realizzato in lega di alluminio estruso curvato e verniciato a polveri con schermo di protezione in policarbonato. Tono bianco, 4000K o 3000K, Potenze da 55W/750mm a 110W/1500mm. Accessori per la sospensione da ordinare separatamente. Alimentatore on-off o dimmerabile incluso nel rosone.

Structure in powder coated curved extrusion of aluminium alloy with opal diffuser. 4000K or 3000K white tone. Powers from 55W/560mm up to 110W/1500mm. Suspension kit to be ordered separately. On-Off or dimmable driver included in the ceiling cup.





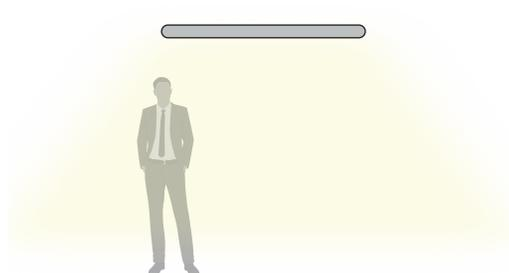

## MINU-R LAP

Realizzati in lega di alluminio estruso curvato verniciato a polveri con schermo di protezione in policarbonato. Tono bianco, 4000K o 3000K, Potenze da 50W/1150mm a 95W/2300mm. Accessori per la sospensione da ordinare separatamente. Alimentatore on-off o dimmerabile incluso nel rosone.

Structure in powder coated curved extrusion of aluminium alloy with opal diffuser. 4000K or 3000K white tone. Powers from 50W/1150mm up to 95W/2300mm. Suspension kit to be ordered separately. On-Off or dimmable Driver included in the ceiling cup.

CE	IP40
LED	RG1
CRI 80/90	50000H
L80 B10	Mac Adam 3

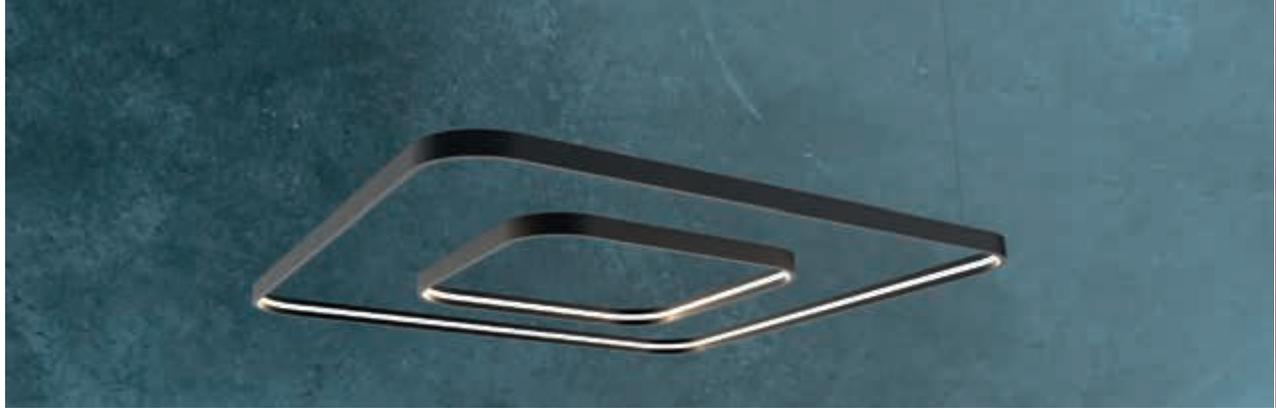

# MINU - R

## S Q U A R E

**Z.**  
COLOR

bianco raggrinzante/rough white -32   
 nero raggrinzante/rough black -33   
 custom -99

OPAL  
1

X.  
CRI80  
5

CRI90  
6

Y.  
4000K  
7

3000K  
8

DIM.  
1-10V  
A1

DALI  
A2

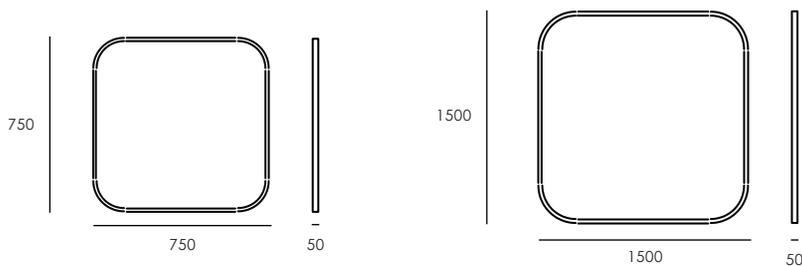

COD. ON/OFF

L.MM

W

LM

MNU.5646. 1 X Y. Z  
MNU.5648. 1 X Y. Z

750  
1500

55W/230V LED  
110W/230V LED

4972/4345  
9460/9100

### ACCESSORI / ACCESSORIES



**MNU.SQ1**  
Kit di sospensione L.2000mm  
e driver 55W.  
Suspension kit L.2000mm and  
driver 55W.



**MNU.SQ3**  
Kit di sospensione L.2000mm  
e driver 110W.  
Suspension kit L.2000mm and  
driver 110W.



CE	IP40
LED	RG1
CRI 80/90	50000H
L80 B10	Mac Adam 3

- 32- bianco raggrinzante/rough white
- 33- nero raggrinzante/rough black
- 99- custom

**Z.**  
COLOR

# MINU - R

## L A P

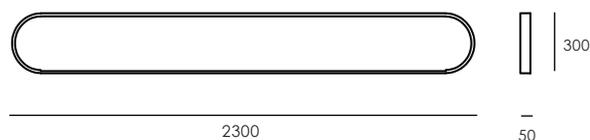
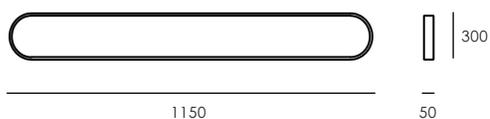

COD. ON/OFF	L.MM	W	LM
MNU.5656. 1 X Y. Z	1150	50W/230V LED	4520/3950
MNU.5659. 1 X Y. Z	2300	95W/230V LED	8170/7860

OPAL  
1

X.  
CRI80  
5

CRI90  
6

Y.  
4000K  
7

3000K  
8

DIM.  
1-10V  
A1

DALI  
A2

### ACCESSORI / ACCESSORIES



**MNU.SL1**  
Kit di sospensione L.2000mm  
e driver 50W.  
Suspension kit L.2000mm and  
driver 50W.



**MNU.SL3**  
Kit di sospensione L.2000mm  
e driver 95W.  
Suspension kit L.2000mm and  
driver 95W.

# ULISSE

Ulisse è un profilo tubolare da interni con effetto luminoso ininterrotto dal design pulito e minimale. Adatto all'illuminazione di ampi spazi domestici, lavorativi e architeturali. Permette un'ottimale diffusione della luce a file singole e continue.

Ulisse is a tubular profile for interiors with an uninterrupted lighting effect with a clean and minimal design. Suitable for lighting large domestic, work and architectural spaces. It allows an optimal diffusion of light in single and continuous rows.

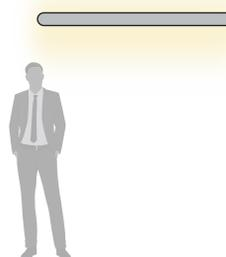

## ULISSE

Profilo tubolare per installazione a soffitto o a sospensione. Corpo in alluminio estruso verniciato a polvere. Diffusore opale.  
Disponibile anche nelle versioni dimmerabili.

Tubular system for ceiling or suspended installation. Body made in powder coated extruded aluminium. Opal diffuser.  
Available also in dimmable versions.



CE	IP20
LED	RG1
CRI 80/90	Driver on/off incl.
L80 B10	Mac Adam 3
	50000H

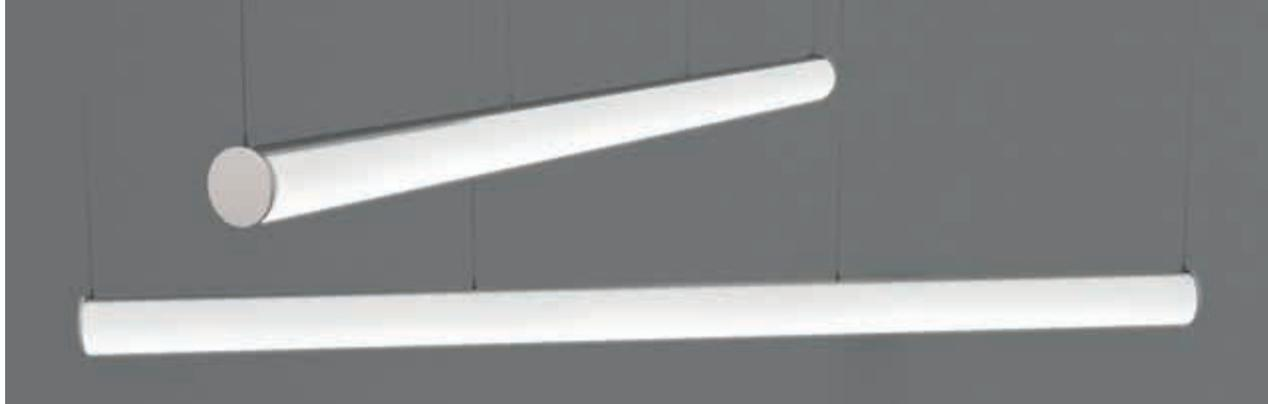

# ULISSE

**Z.**  
COLOR

bianco/white -02   
custom -99

OPAL  
0

X.  
CRI80  
5

CRI90  
6

Y.  
4000K  
7

3000K  
8

DIM.  
1-10V  
A1

DALI  
A2

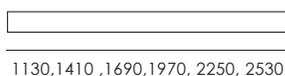
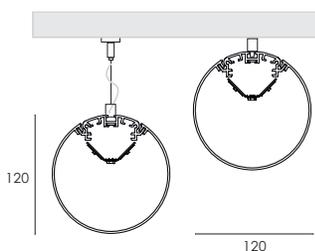

COD. ON/OFF	L.MM	W	LM
ULS.3363.0 X Y. Z	1130	56W/230V LED	7640/7240
ULS.3364.0 X Y. Z	1410	70W/230V LED	9560/9080
ULS.3365.0 X Y. Z	1690	84W/230V LED	11460/10860
ULS.3366.0 X Y. Z	1970	97W/230V LED	13380/12700
ULS.3367.0 X Y. Z	2250	112W/230V LED	15280/14480
ULS.3368.0 X Y. Z	2530	126W/230V LED	17200/16320

## ACCESSORI / ACCESSORIES

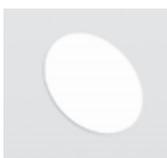

**ULS.TE**  
Testata di chiusura.  
End cap.



**ULS.CD**  
Giunto lineare.  
Linear joint.



**ULS.SO**  
Sospensioni (coppia).  
Suspension kit (pair).



**ULS.AP**  
Attacco a parete e plafone  
(coppia).  
Wall bracket and ceiling(pair).



**AAA.RA2**  
Rosone alimentato basic.  
Power supply basic.



# ROUND



Profilo tubolare semplice e funzionale. Disponibile in diverse lunghezze per adattarsi ai diversi ambienti ed alle più svariate soluzioni di arredo. Pensato per l'ufficio trova la sua collocazione anche in ambienti domestici quali ingressi, corridoi e disimpegni.

Simple and functional tubular profile. Available in different lengths to adapt to different environments and to the most varied furnishing solutions. Designed for the office, it also finds its place in domestic environments such as entrances, corridors and hallways.



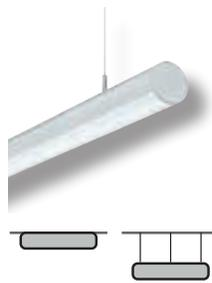

## ROUND

Round è un apparecchio di illuminazione tubolare per interni installabile singolarmente o in file continue con un effetto luminoso ininterrotto.

Round is a tubular lighting fitting for indoor that can be installed alone or in continuous lines with an uninterrupted lighting effect.

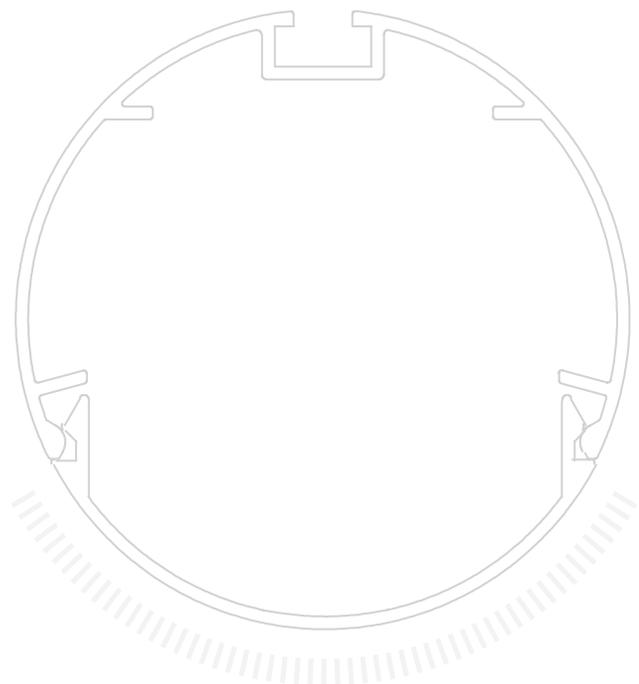

CE	IP20
LED	RG1
CRI 80/90	Driver on/off incl.
L80 B10	Mac Adam 3
⏏	50000H



# ROUND

Z. COLOR

bianco/white -02   
 nero/black -03   
 custom -99

OPAL  
0

X.  
CRI80  
5

CRI90  
6

Y.  
5000K  
6

4000K  
7

3000K  
8

DIM.  
1-10V  
A1

DALI  
A2

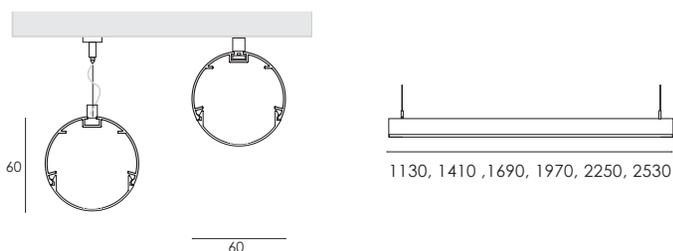

COD. ON/OFF

L.MM

W

LM

COD. ON/OFF	L.MM	W	LM
<b>F65.3613.0 X Y. Z</b>	1130	28W/230V LED	3920/3820/3620
<b>F65.3614.0 X Y. Z</b>	1410	35W/230V LED	4910/4780/4540
<b>F65.3615.0 X Y. Z</b>	1690	42W/230V LED	5880/5730/5430
<b>F65.3616.0 X Y. Z</b>	1970	49W/230V LED	6870/6690/6350
<b>F65.3617.0 X Y. Z</b>	2250	56W/230V LED	7840/7640/7240
<b>F65.3618.0 X Y. Z</b>	2530	63W/230V LED	8830/8600/8160

## ACCESSORI / ACCESSORIES

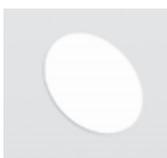

**F65.TE**  
Testata di chiusura.  
End cap.



**F65.CD**  
Giunto lineare.  
Linear joint.



**AAA.SO**  
Sospensioni (coppia).  
Suspension kit (pair).



**AAA.RA2**  
Rosone alimentato basic.  
Power supply basic.



**TNI.DP**  
Attacco plafone (coppia).  
Ceiling bracket (pair).



# SHADOW

Profilo dalle linee sobrie e discrete, è adatto ad illuminare uffici ed ambienti di lavoro. Nella versione a luce diretta ed indiretta è la soluzione ideale per creare un ambiente accogliente dai toni più morbidi e sfumati.

Profile with sober and discreet lines, it is suitable for lighting offices and work environments. In the direct and indirect light version, it is the ideal solution to create a welcoming environment with softer tones.

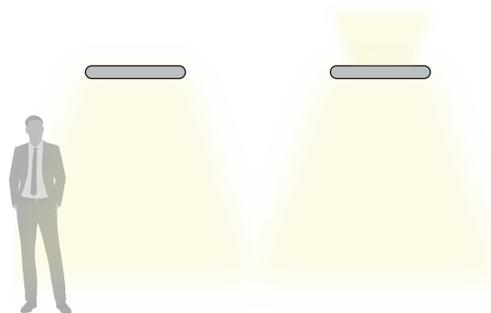
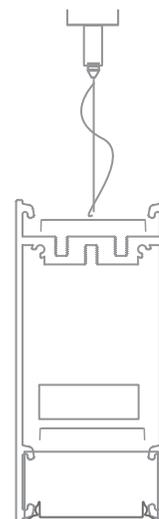

## SHADOW

Sistema modulare in alluminio estruso da plafone o sospensione. Driver ON/OFF o dimmerabile incluso. Diffusore opale o microprismato incluso. Accessori da ordinare separatamente.

Modular system in extruded aluminium for ceiling or suspended installation. ON/OFF or dimmable Driver included. Opal or microprismatic diffuser included. Accessories to be ordered separately.

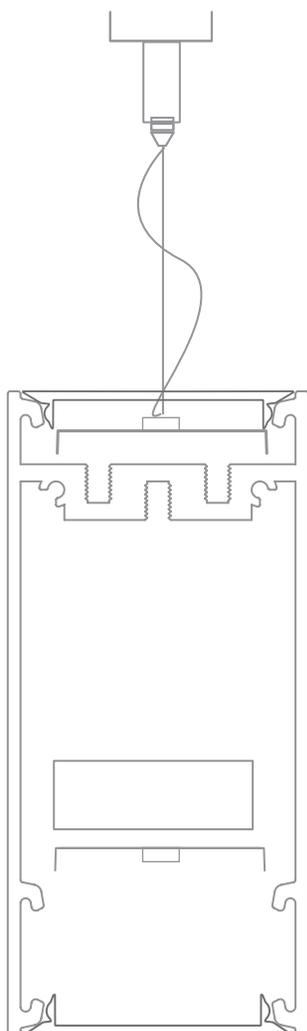

CE	IP20
LED	RG1
CRI 80/90	Driver on/off incl.
L80 B10	Mac Adam 3
	50000H



# SHADOW

Z. COLOR

bianco/white -02   
 nero/black -03   
 custom -99

D. OPAL 0

MICRO PRISMATIC 9

X. CRI80 5

CRI90 6

Y. 5000K 6

4000K 7

3000K 8

DIM. 1-10V A1

DALI A2

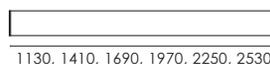
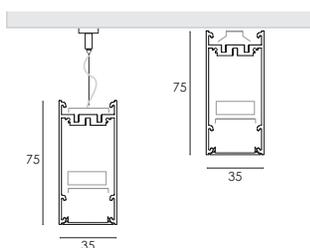

COD. ON / OFF	L.MM	W	LM
DIRETTA/DIRECT			
LSA.4753.D X Y. Z	1130	28W/230V LED	3920/3820/3620
LSA.4754.D X Y. Z	1410	35W/230V LED	4910/4780/4540
LSA.4755.D X Y. Z	1690	42W/230V LED	5880/5730/5430
LSA.4756.D X Y. Z	1970	49W/230V LED	6870/6690/6350
LSA.4757.D X Y. Z	2250	56W/230V LED	7840/7640/7240
LSA.4758.D X Y. Z	2530	63W/230V LED	8830/8600/8160
DIRETTA.INDIRETTA/DIRECT.INDIRECT			
LSA.4853.D X Y. Z	1130	42W/230V LED	5880/5730/5430
LSA.4854.D X Y. Z	1410	49W/230V LED	6870/6690/6350
LSA.4855.D X Y. Z	1690	63W/230V LED	8830/8600/8160
LSA.4856.D X Y. Z	1970	77W/230V LED	10790/10510/10860
LSA.4857.D X Y. Z	2250	84W/230V LED	11760/11460/11320
LSA.4858.D X Y. Z	2530	91W/230V LED	12750/12420/11780

## ACCESSORI / ACCESSORIES



**LSA.TE**  
 Testata di chiusura.  
 End cap.



**LSA.CD**  
 Giunto lineare.  
 Linear joint.



**LSA.SO**  
 Sospensioni (coppia).  
 Suspension kit (pair).



**AAA.RA2**  
 Rosone alimentato basic.  
 Power supply basic.



**LSA.DP**  
 Attacco plafone (coppia).  
 Ceiling bracket (pair).



# COCKTAIL

## Cocktail Diffuser

Cocktail è un profilo d'illuminazione installabile singolarmente o in fila continua a plafone e sospensione dal design moderno e curato. Le molteplici lunghezze abbinante a fasci e diffusori diversi, lo rendono un sistema versatile e protagonista in svariate soluzioni d'arredo: la versione con ottiche a micro celle viene scelta laddove serve fascio controllato, mentre dove è necessaria un'illuminazione più estesa si predilige la versione con diffusore.

Cocktail is a family of LED linear lighting systems for single or continuous lines, for ceiling or suspended installation with a modern and refined design. The different lengths combined with the various beams and diffusers make it the ideal choice in different solutions: the micro-cell optic for the beam control, the diffuser version for general lighting.





Cocktail  
UGR



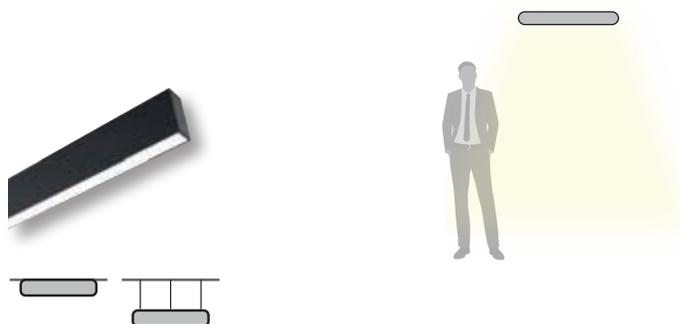

## COCKTAIL DIFFUSER

Corpo in estruso di alluminio, testate in acciaio, verniciatura a polveri. Diffusore in policarbonato. Tono luce bianco 4000K o 3000K. Potenze da 28W/1130mm a 56W/2250mm. Alimentatore elettronico e diffusore inclusi. Testate, giunti lineari ed accessori per la sospensione da ordinare a parte.

Structure in powder coated aluminium alloy, steel end caps. Opal polycarbonate diffuser. LED in 4000K or 3000K white tone. Powers from 28W/1130mm up to 56W/2250mm. Electronic driver and diffuser included. End caps, junctions, and kit for suspended installation to be ordered separately.

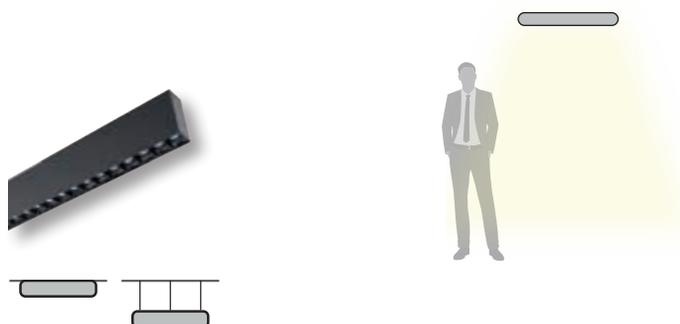

## COCKTAIL UGR

Corpo in lega di alluminio, testate in acciaio, verniciatura a polveri. Controllo dell'abbagliamento UGR19 grazie ad un innovativo sistema di ottiche a micro-celle. Tono luce bianco 4000K o 3000K, Potenze da 36W/1190mm a 85W/2245mm. Alimentatore elettronico incluso. Testate, Giunti lineari ed accessori per la sospensione da ordinare a parte.

Structure in powder coated aluminium alloy, steel end caps. Glare control UGR19 thanks to the innovative micro-cells system. LED in 4000K or 3000K white tone. Powers from 36W/1190mm up to 85W/2245mm. Electronic driver included. End caps, junctions, and kit for suspended installation to be ordered separately.

CE	IP20
LED	RG1
CRI 80/90	Driver on/off incl.
L80 B10	Mac Adam 3
⏏	50000H



# COCKTAIL

## DIFFUSER

Z.  
COLOR

bianco/white -02   
 nero/black -03   
 custom -99

OPAL  
0

X.  
CRI80  
5

CRI90  
6

Y.  
5000K  
6

4000K  
7

3000K  
8

DIM.  
1-10V  
A1

DALI  
A2

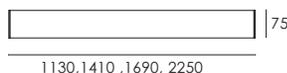
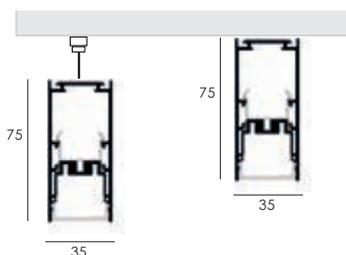

COD. ON/OFF	L.MM	W	LM
CTL.3553.0 X Y. Z	1130	28W/230V LED	3920/3820/3620
CTL.3554.0 X Y. Z	1410	35W/230V LED	4910/4780/4540
CTL.3555.0 X Y. Z	1690	42W/230V LED	5880/5730/5430
CTL.3557.0 X Y. Z	2250	56W/230V LED	7840/7640/7240

### ACCESSORI / ACCESSORIES



**CTL.TE**  
Testata di chiusura.  
End cap.



**CTL.CD**  
Giunto lineare.  
Linear joint.



**CTL.SO**  
Sospensioni (coppia).  
Suspension kit (pair).



**AAA.RA2**  
Rosone alimentato basic.  
Power supply basic.



**CTL.DP**  
Attacco plafone (coppia).  
Ceiling bracket (pair).

Controllo dell'abbagliamento UGR < 19  
Glare control UGR < 19

CE	IP20
LED	RG1
CRI 80/90	Driver on/off incl.
L80 B10	Mac Adam 3
	50000H

- 02- bianco/white
- 03- nero/black
- 99- custom

**Z.**  
COLOR

# COCKTAIL

## UGR

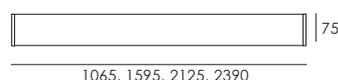
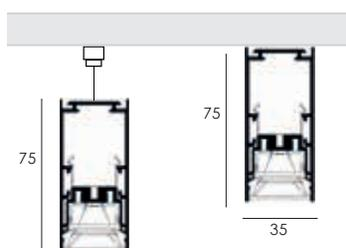

COD. ON/OFF

L.MM

W

LM

COD. ON/OFF	L.MM	W	LM
CTL.3573.1 X Y. Z	1065	45W/230V LED	7920/8070
CTL.3574.1 X Y. Z	1595	65W/230V LED	11400/11657
CTL.3575.1 X Y. Z	2125	85W/230V LED	12240/12390
CTL.3577.1 X Y. Z	2390	95W/230V LED	13680/13847

LENSES 15°	1
X. CR180	5
CR190	6
Y. 5000K	6
4000K	7
3000K	8
DIM. 1-10V	A1
DALI	A2

### ACCESSORI / ACCESSORIES



**CTL.TE**  
Testata di chiusura.  
End cap.



**CTL.CD**  
Giunto lineare.  
Linear joint.



**CTL.SO**  
Sospensioni (coppia).  
Suspension kit (pair).



**AAA.RA2**  
Rosone alimentato basic.  
Power supply basic.



**CTL.DP**  
Attacco plafone (coppia).  
Ceiling bracket (pair).

# T-UNI

## T-Uni Lens



## T-Uni Recessed



T-Uni è una famiglia di sistemi lineari LED installabili singolarmente in molteplici modalità: in fila continua, a plafone, sospensione ed incasso nel controsoffitto. Elegante nel design, si presta alle applicazioni più diverse, integrandosi perfettamente in contesti residenziali, commerciali, business ed education.

T-Uni is a family of LED linear systems for single or continuous lines, for ceiling, suspended or recessed use.

Its elegant design perfectly integrates T-Uni to various applications in residential, commercial and business environments.

T-Uni



T-Uni UGR



T-Uni Recessed  
Frameless



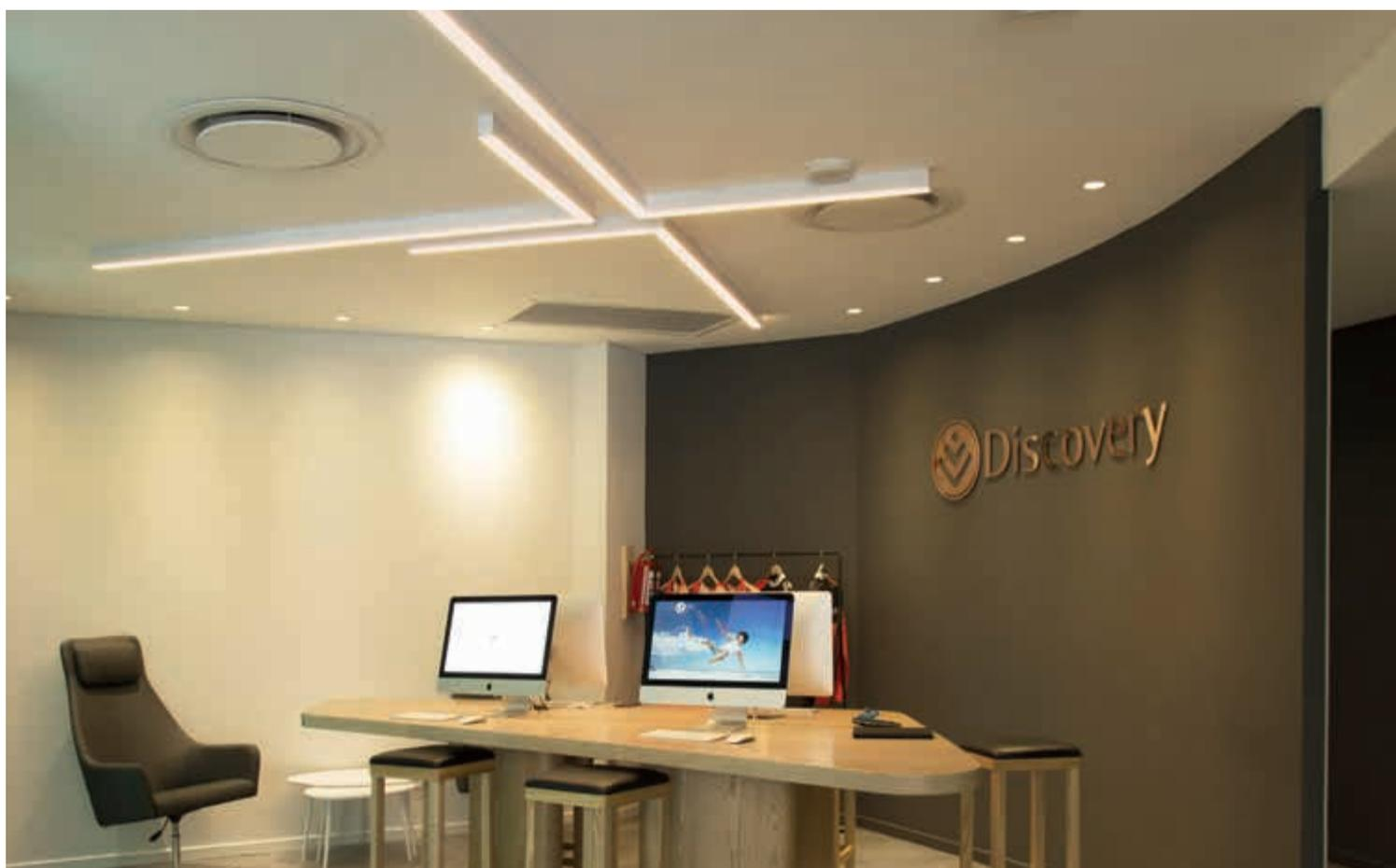
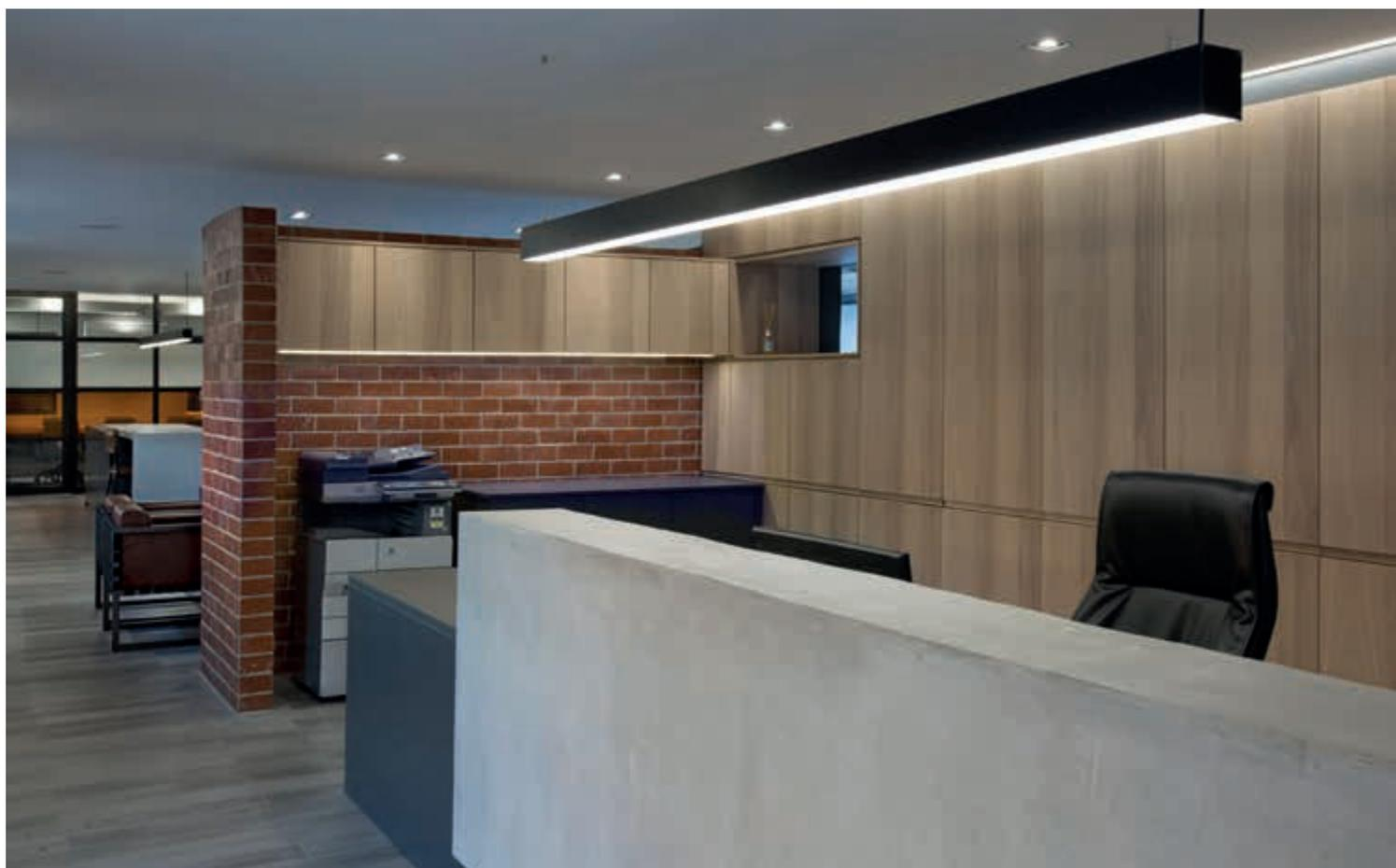



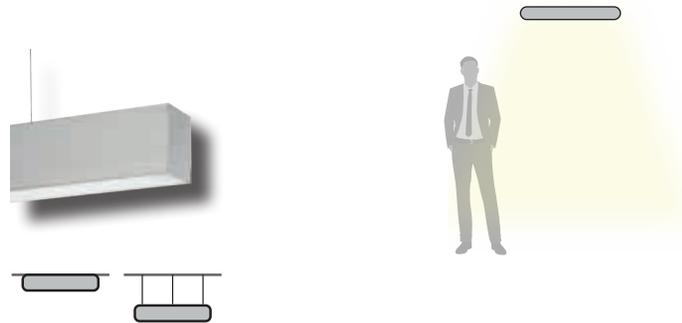

## T-UNI

Corpo in lega di alluminio, testate in acciaio, verniciatura a polveri. Diffusore in policarbonato opale o microprismato. Tono luce bianco 5500K, 4000K o 3000K. Potenze da 28W/1130mm a 63W/2530mm. Alimentatore elettronico e diffusore inclusi. Testate, giunti lineari ed accessori per la sospensione da ordinare separatamente.

Structure in powder coated aluminium alloy, steel end caps. Opal or microprismatic diffuser. LED in 5500K, 4000K or 3000K white tone.

Powers from 28W/1130mm up to 63W/2530mm.

Electronic driver and diffuser included. End caps, linear joint and kit for suspended installation to be ordered separately.

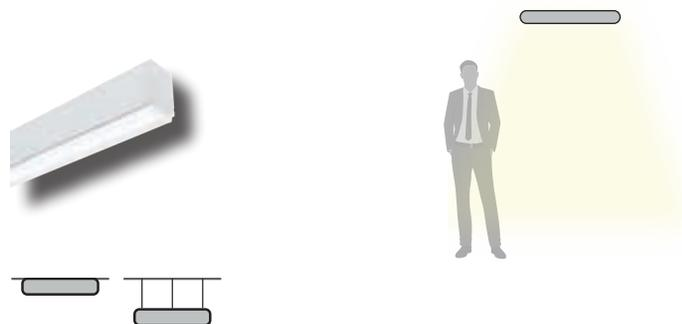

## T-UNI LENS

Corpo in lega di alluminio, testate in acciaio, verniciatura a polveri. Ottiche a fascio stretto, largo o retail con micro lenti per il controllo dell'abbagliamento.

Tono di luce bianco 5500K, 4000K o 3000K. Potenze da 32W/1130mm a 71W/2530mm. Alimentatore elettronico incluso. Testate, giunti lineari ed accessori per la sospensione da ordinare a parte.

Structure powder coated aluminium alloy, steel end caps. Narrow, wide, asymmetric and retail beam optics, with micro lenses and glare control. LED in 5500K, 4000K or 3000K white tone.

Powers from 32W/1130mm up to 71W/2530mm. Electronic driver and diffuser included.

Electronic driver and diffuser included. End caps, linear joint and kit for suspended installation to be ordered separately.

CE	IP43
LED	RG1
CRI 80/90	Driver on/off incl.
L80 B10	Mac Adam 3
	50000H



# T - U N I

Z. COLOR

bianco/white -02   
 nero/black -03   
 custom -99

D. OPAL 0

MICRO PRISMATIC 9

X. CR180 5

CR190 6

Y. 5500K 6

4000K 7

3000K 8

DIM. 1-10V A1

DALI A2

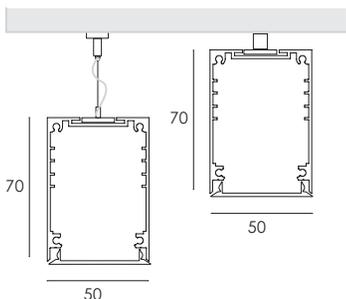

1130, 1410, 1690, 1970, 2250, 2530

COD. ON/OFF	L.MM	W	LM
<b>TNI. 3403.D X Y. Z</b>	1130	28W/230V LED	3920/3820/3620
<b>TNI. 3404.D X Y. Z</b>	1410	35W/230V LED	4910/4780/4540
<b>TNI. 3405.D X Y. Z</b>	1690	42W/230V LED	5880/5730/5430
<b>TNI. 3406.D X Y. Z</b>	1970	49W/230V LED	6870/6690/6350
<b>TNI. 3407.D X Y. Z</b>	2250	56W/230V LED	7840/7640/7240
<b>TNI. 3408.D X Y. Z</b>	2530	63W/230V LED	8830/8600/8160

## ACCESSORI / ACCESSORIES



**TNI.TE**  
 Testata di chiusura.  
 End cap.



**TNI.CD**  
 Giunto lineare.  
 Linear joint.



**TNI.SO**  
 Sospensioni (coppia).  
 Suspension kit (pair).



**AAA.RA2**  
 Rosone alimentato basic.  
 Power supply basic.



**TNI.DP**  
 Attacco plafone (coppia).  
 Ceiling bracket (pair).



CE	IP43
LED	RG1
CRI 80/90	Driver on/off incl.
L80 B10	Mac Adam 3
⏏	50000H

- 02- bianco/white
- 03- nero/black
- 99- custom

**Z.**  
COLOR

# T - UNI

## LENSES

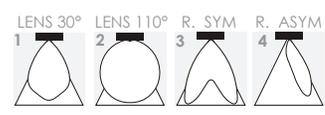
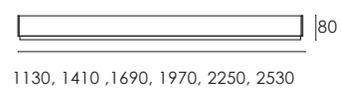
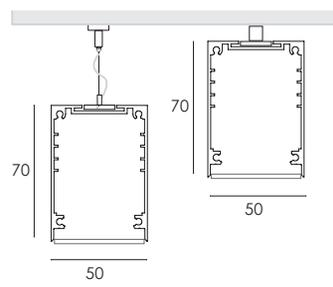

COD. ON/OFF	L.MM	W	LM
TNL.3463.D X Y. Z	1130	32W/230V LED	5020/4600/4400
TNL.3464.D X Y. Z	1410	40W/230V LED	6275/5750/5500
TNL.3465.D X Y. Z	1690	48W/230V LED	7530/6900/6600
TNL.3466.D X Y. Z	1970	55W/230V LED	8785/8050/7200
TNL.3467.D X Y. Z	2250	63W/230V LED	10040/9200/8800
TNL.3468.D X Y. Z	2530	71W/230V LED	11295/10350/9900

**D.**  
LENSES 30° 1

LENSES 110° 2

LENSES SYM° 3

LENSES ASYM° 4

**X.**  
CRI80 5

CRI90 6

**Y.**  
5500K 6

4000K 7

3000K 8

**DIM.**  
1-10V A1

DALI A2

### ACCESSORI / ACCESSORIES



**TNL.TE**  
Testata di chiusura.  
End cap.



**TNL.CD**  
Giunto lineare.  
Linear joint.



**TNL.SO**  
Sospensioni (coppia).  
Suspension kit (pair).



**AAA.RA2**  
Rosone alimentato basic.  
Power supply basic.



**TNL.DP**  
Attacco plafone (coppia).  
Ceiling bracket (pair).





## T-UNI UGR

Corpo in lega di alluminio, testate in acciaio, verniciatura a polveri. Controllo dell'abbagliamento UGR < 19 grazie ad un innovativo sistema di ottiche a micro-celle. Tono luce bianco 4000K o 3000K. Potenze da 29W/1130mm a 66W/2530mm. Alimentatore elettronico incluso. Testate, giunti lineari ed accessori per la sospensione da ordinare a parte.

Structure in powder coated aluminium alloy, steel end caps. Glare control UGR < 19 thanks to the innovative micro-cells systems. LED in 4000K or 3000K white tone. Powers from 29W/1130mm up to 66W/2530mm. Electronic driver included. End caps, linear joint, and kit for suspended installation to be ordered separately.

Controllo dell'abbagliamento UGR < 19  
Glare control UGR < 19

CE	IP43
LED	RG1
CRI 90	Driver on/off incl.
L80 B10	Mac Adam 3
	50000H



# T - U N I

## U G R

Z.  
COLOR

bianco/white -02   
nero/black -03   
custom -99

D.  
LENSES  
60° 1

LENSES  
90° 2

LENSES  
ASYM° 3

CRI90  
6

Y.  
4000K  
7

3000K  
8

DIM.  
1-10V  
A1

DALI  
A2

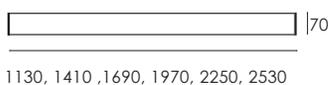
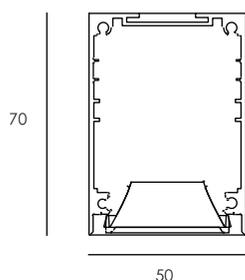

COD. ON/OFF	L.MM	W	LM
TNR.3473.D 6 Y. Z	1130	29W/230V LED	4416/4149
TNR.3474.D 6 Y. Z	1410	37W/230V LED	5519/5173
TNR.3475.D 6 Y. Z	1690	44W/230V LED	6623/6208
TNR.3476.D 6 Y. Z	1970	51W/230V LED	7727/7243
TNR.3477.D 6 Y. Z	2250	59W/230V LED	8831/8278
TNR.3478.D 6 Y. Z	2530	66W/230V LED	9935/9312

### ACCESSORI / ACCESSORIES



**TNI.TE**  
Testata di chiusura.  
End cap.



**TNI.CD**  
Giunto lineare.  
Linear joint.



**TNI.SO**  
Sospensioni (coppia).  
Suspension kit (pair).



**AAA.RA2**  
Rosone alimentato basic.  
Power supply basic.



**TNI.DP**  
Attacco plafone (coppia).  
Ceiling bracket (pair).

ASYM



60°



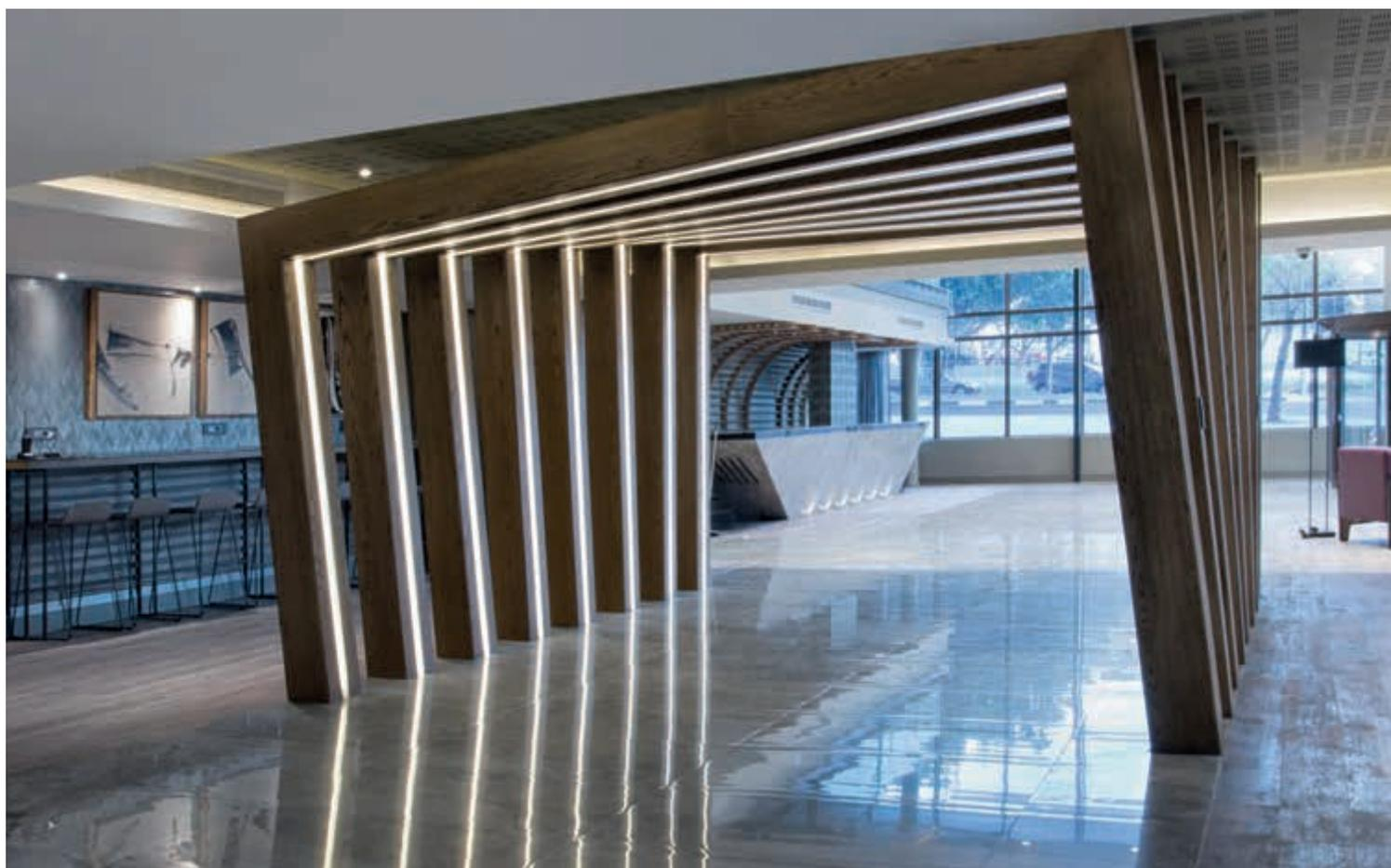





## T-UNI RECESSED

Corpo in lega di alluminio, testate in acciaio, verniciatura a polveri. Diffusore in policarbonato opale o microprismato. Tono luce bianco 5500K, 4000K o 3000K.

Potenze da 28W/1130mm a 63W/2530mm.

Alimentatore elettronico e diffusore inclusi. Testate, giunti lineari ed accessori per l'incasso da ordinare separatamente.

Structure in powder coated aluminium alloy, steel end caps. Opal or microprismatic diffuser.

LED in 5500K, 4000K or 3000K white tone.

Powers from 28W/1130mm up to 63W/2530mm.

Electronic driver and diffuser included. End caps, linear joint and kit for recessed installation to be ordered separately.



## T-UNI RECESSED FRAMELESS

Corpo in lega di alluminio, testate in acciaio, verniciatura a polveri. Diffusore in policarbonato opale o microprismato. Tono luce bianco 5500K, 4000K o 3000K. Potenze da 28W/1130mm a 63W/2530mm.

Alimentatore elettronico e diffusore inclusi. Testate, giunti lineari ed accessori per l'incasso da ordinare separatamente.

Structure in powder coated aluminium alloy, steel end caps. Opal or microprismatic diffuser.

LED in 5500K, 4000K or 3000K white tone.

Powers from 28W/1130mm up to 63W/2530mm.

Electronic driver and diffuser included. End caps, linear joint and kit for recessed installation to be ordered separately.

CE	IP40
LED	RG1
CRI 80/90	Driver on/off incl.
L80 B10	Mac Adam 3
	50000H



# T - UNI RECESSED

Z.  
COLOR

bianco/white -02   
 nero/black -03   
 custom -99

D.  
OPAL  
0

MICRO PRISMATIC  
9

X.  
CRI80  
5

CRI90  
6

Y.  
5500K  
6

4000K  
7

3000K  
8

DIM.  
1-10V  
A1

DALI  
A2

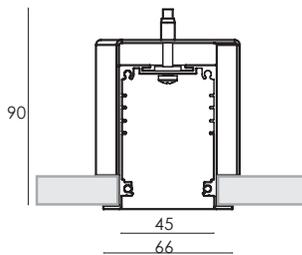

- 1425x58 -  
Cutout / Foro: 98x31mm



1145, 1425, 1705, 1985, 2265, 2545

COD. ON/OFF	L.MM	W	LM
TNC.3443.D X Y. Z	1130	28W/230V LED	3920/3820/3620
TNC.3444.D X Y. Z	1410	35W/230V LED	4910/4780/4540
TNC.3445.D X Y. Z	1690	42W/230V LED	5880/5730/5430
TNC.3446.D X Y. Z	1970	49W/230V LED	6870/6690/6350
TNC.3447.D X Y. Z	2250	56W/230V LED	7840/7640/7240
TNC.3448.D X Y. Z	2530	63W/230V LED	8830/8600/8160

## ACCESSORI / ACCESSORIES



**TNC.TE**  
Testata di chiusura.  
End cap.



**TNC.MF**  
Staffa di fissaggio.  
Fixing bracket.



**TNC.CD**  
Giunto lineare.  
Linear joint.



**TNC.CA**  
Cavo anticaduta.  
Suspension cable.



CE	IP40
LED	RG1
CRI 80/90	Driver on/off incl.
L80 B10	Mac Adam 3
⏚	50000H

- 02- bianco/white
- 03- nero/black
- 99- custom

**Z.**  
COLOR

# T - UNI

## RECESSED FRAMELESS

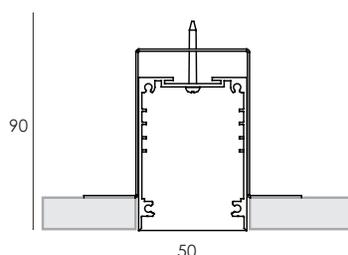

1425x58 -  
Cutout / Foro: 98x31mm



1136, 1416, 1696, 1976, 2256, 2536

**D.**  
OPAL  
**0**

MICRO  
PRISMATIC  
**9**

**X.**  
CRI80  
**5**

CRI90  
**6**

**Y.**  
5500K  
**6**

4000K  
**7**

3000K  
**8**

**DIM.**  
1-10V  
**A1**

DALI  
**A2**

**COD. ON/OFF**

**L.MM**

**W**

**LM**

<b>TNE.3423.D X Y. Z</b>	1130	28W/230V LED	3920/3820/3620
<b>TNE.3424.D X Y. Z</b>	1410	35W/230V LED	4910/4780/4540
<b>TNE.3425.D X Y. Z</b>	1690	42W/230V LED	5880/5730/5430
<b>TNE.3426.D X Y. Z</b>	1970	49W/230V LED	6870/6690/6350
<b>TNE.3427.D X Y. Z</b>	2250	56W/230V LED	7840/7640/7240
<b>TNE.3428.D X Y. Z</b>	2530	63W/230V LED	8830/8600/8160

### ACCESSORI / ACCESSORIES



**TNE.TE**  
Testata di chiusura.  
End cap.



**TNE.MF**  
Staffa di fissaggio.  
Fixing bracket.



**TNC.CD**  
Giunto lineare.  
Linear joint.



**TNC.CA**  
Cavo anticaduta.  
Suspension cable.

# T - 3

Serie di profili da sospensione, plafone e da incasso. La versione senza cornice, dalle dimensioni ridotte, massimizza la funzionalità del prodotto. Ideale negli spazi conviviali per incorniciare tavoli da pranzo o valorizzare living room ed open spaces.

Series of suspended, ceiling and recessed profiles. The frameless version, with reduced dimensions, increases functionality. Ideal in convivial spaces to frame dining tables or enhance living rooms and open spaces.



T-3  
Recessed  
Frameless

T-3  
Suspended



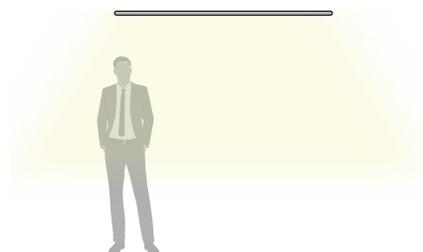

## T-3

Sistema modulare in alluminio estruso da plafone o sospensione. Disponibile in due versioni con diffusore opale o microprismato. Accessori da ordinare separatamente.

Modular system in extruded aluminium for ceiling or suspended installation. Available in two versions with opal or microprismatic diffuser. Accessories to be ordered separately.

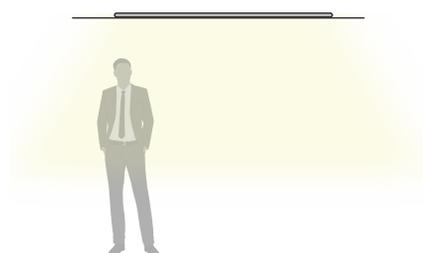

## T-3 RECESSED FRAMELESS

Sistema modulare in alluminio estruso da incasso a scomparsa totale. Adatto per cartongesso spessore 9-13 mm. Driver on/off e diffusore opale o microprismato inclusi. Testate ed accessori da ordinare a parte.

Modular system in extruded aluminium for trimless recessed installation. Suitable for plasterboards of thickness 9-13 mm. Driver and opal or microprismatic diffuser are included. End caps and accessories to be ordered separately.

CE	IP20
LED	RG1
CRI 90	Driver on/off incl.
L80 B10	Mac Adam 3
	50000H

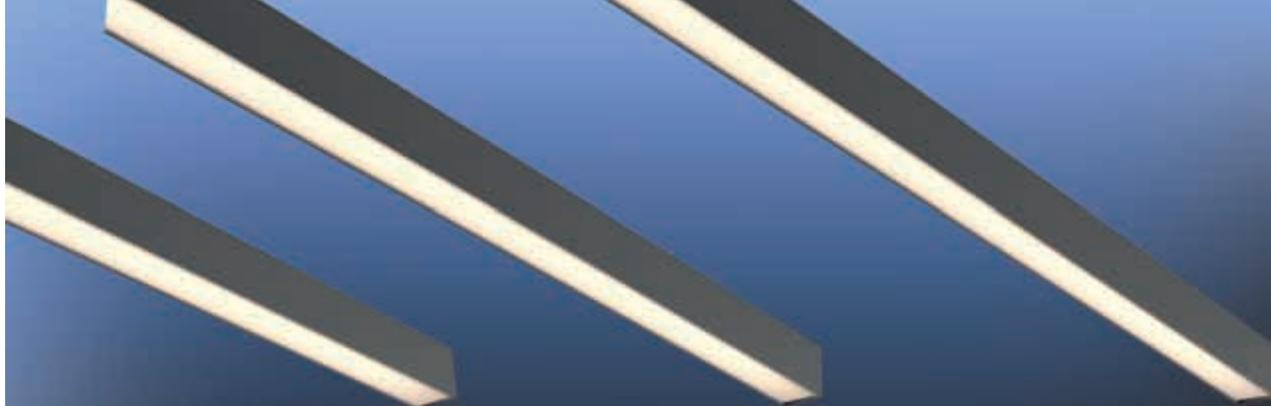

# T - 3

**Z.**  
COLOR

bianco/white -02   
nero/black -03

**D.**  
OPAL  
0

MICRO  
PRISMATIC  
9

4000K  
7

3000K  
8

**DIM.**  
1-10V  
A1

DALI  
A2

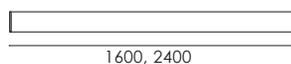
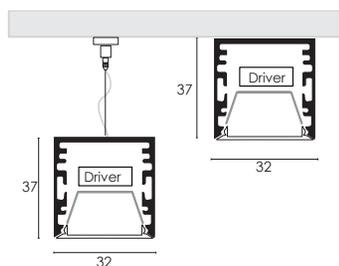

COD. ON/OFF	L.MM	W	K	LM
<b>T31.3703.D 6 7. Z</b>	1600	40W/230V LED	4000K	3070
<b>T31.3703.D 6 8. Z</b>	1600	40W/230V LED	3000K	2780
<b>T31.3705.D 6 7. Z</b>	2400	60W/230V LED	4000K	4600
<b>T31.3705.D 6 8. Z</b>	2400	60W/230V LED	3000K	4170

## ACCESSORI / ACCESSORIES



**T3X.TEA**  
Testata di chiusura.  
End cap.



**T3X.SO**  
Kit di sospensione (coppia).  
Suspension kit (pair).



**T3X.CDA**  
Giunto lineare.  
Linear joint.



**AAA.RA2**  
Rosone alimentato basic.  
Power supply basic.





CE	IP20
<b>LED</b>	<b>RG1</b>
CRI 90	Driver on/off incl.
L80 B10	Mac Adam 3
	50000H

# T - 3

## RECESSED FRAMELESS

02- bianco/white

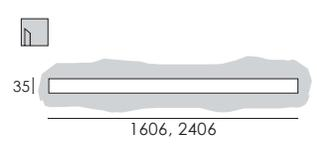
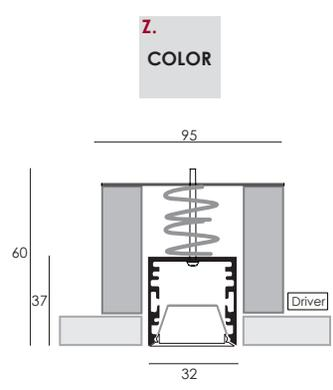

COD. ON/OFF	L.MM	W	K	LM
<b>T3E.3723.D 6 7. Z</b>	1600	40W/230V LED	4000	3070
<b>T3E.3723.D 6 8. Z</b>	1600	40W/230V LED	3000	2780
<b>T3E.3725.D 6 7. Z</b>	2400	60W/230V LED	4000	4600
<b>T3E.3725.D 6 8. Z</b>	2400	60W/230V LED	3000	4170

**D.**  
OPAL  
**0**

MICRO PRISMATIC  
**9**

**4000K**  
**7**

**3000K**  
**8**

**DIM.**  
1-10V  
**A1**

**DALI**  
**A2**

### ACCESSORI / ACCESSORIES



**T3X.TEA**  
Testata di chiusura.  
End cap.



**T3X.CLT**  
Giunto a 3 vie.  
3 way joint.

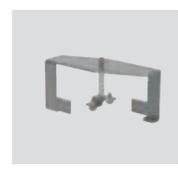

**T3X.MFB**  
Staffa di fissaggio.  
Fixing bracket.



**T3X.CLV**  
Giunto verticale.  
Vertical joint.



**T3X.CDA**  
Giunto lineare.  
Linear joint.



**TNC.CA**  
Cavo anticaduta.  
Suspension cable.

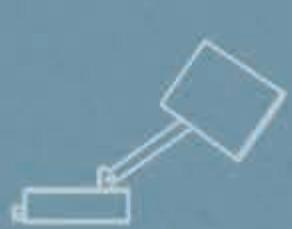
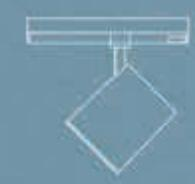
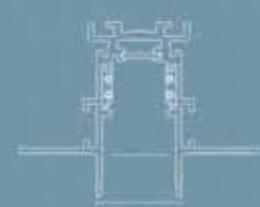
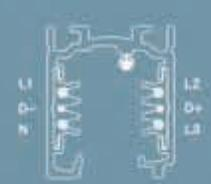

# FARETTI Spotlights



**Indoor**

# DIVA

## Plus

Diva è una serie di proiettori a LED per binario Unitrack e per installazione a parete. Design essenziale e proporzioni eleganti sono le caratteristiche principali della sua estetica studiata per ottimizzare la gestione passiva del calore. Utilizza ottiche speculari e lenti di ultima generazione. Costruita interamente in Italia, la serie Diva è apprezzata in tutto il mondo per l'eccellente rapporto qualità/prezzo.

DIVA is a series of led projectors for Unitrack and for wall use. Essential design and elegant proportions are the main features of its aesthetics designed to optimize passive heat management. Diva can be equipped with various reflectors or lenses. Diva family is entirely made in Italy and highly appreciated all over the world for its excellent price/quality ratio.

Abbinato al **binario 230V**  
Match with **230V track**

pag. 212



In



Base

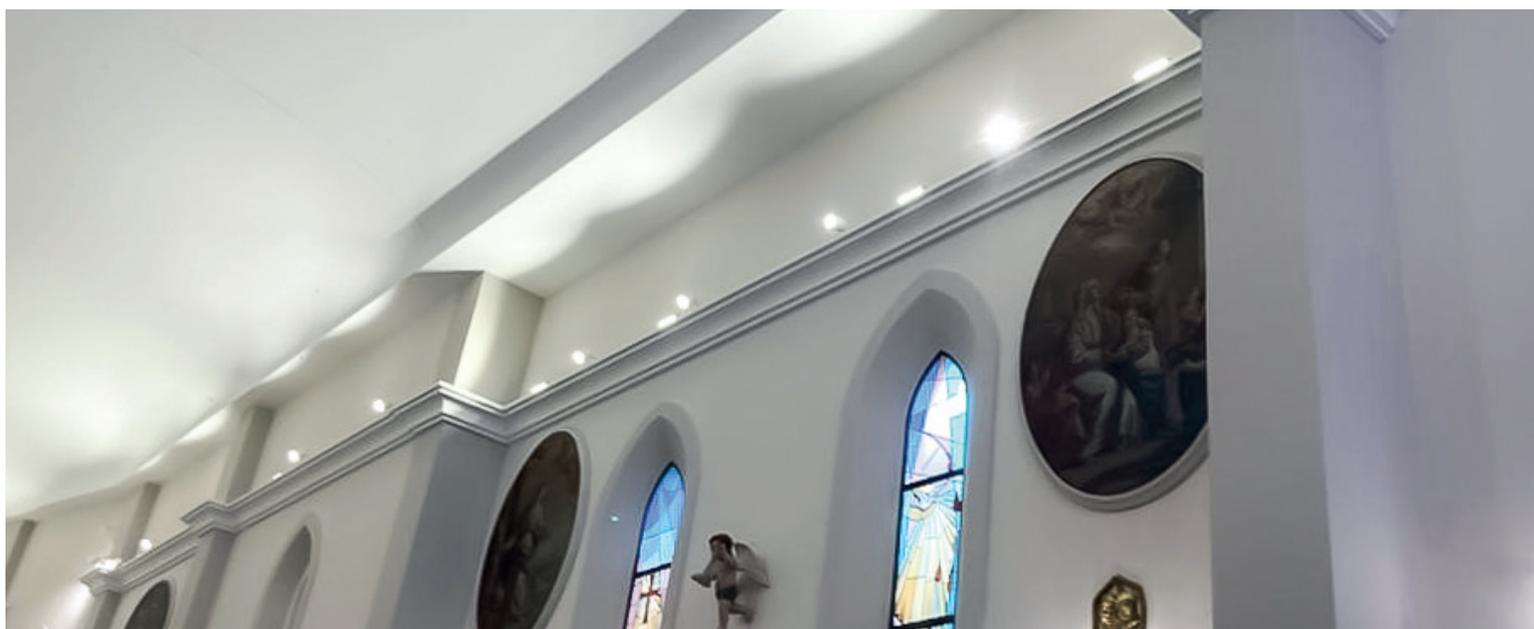
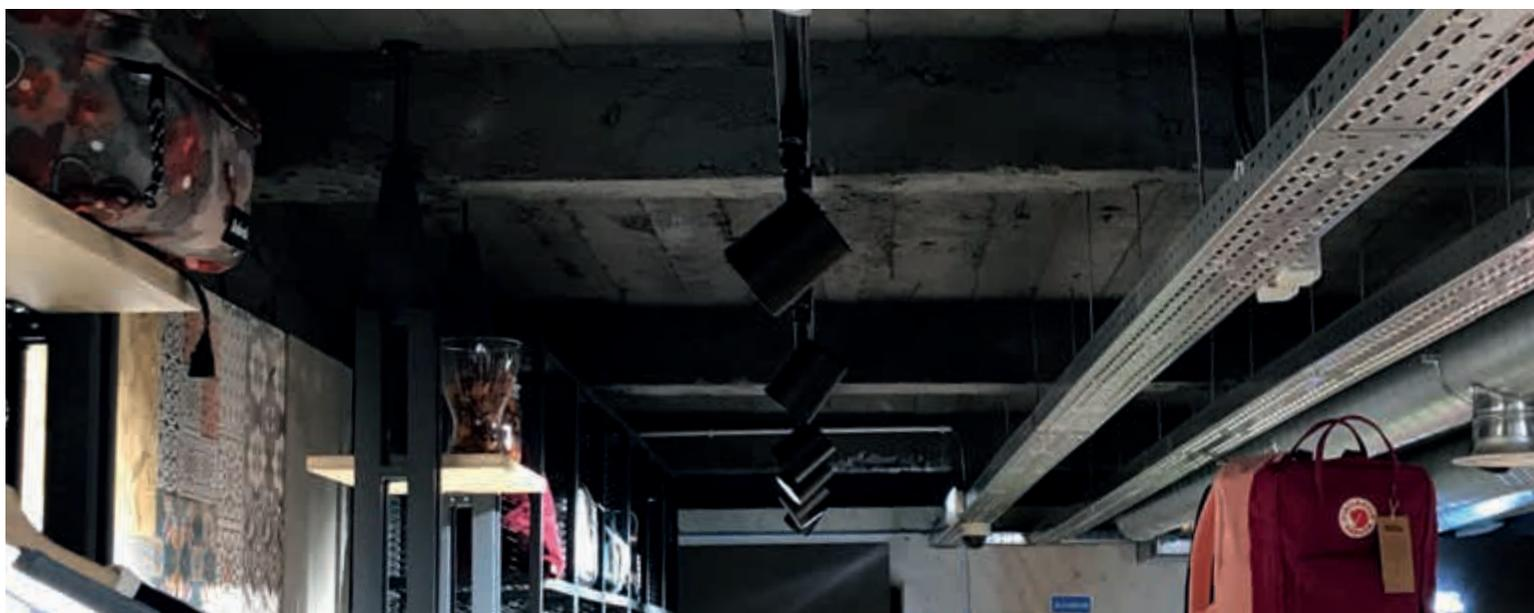



## DIVA IN

Corpo ottico, anello e braccio pressofusi in lega di alluminio con verniciatura a polveri. Sorgente luminosa a LED chip on board, CRI 90 o superiore, tono luce bianco 4000K o 3000K, Potenze da 25W a 32W. Alimentatore elettronico incluso nell'adattatore da binario trifase.

Body, ring and arm in powder coated die-cast aluminum alloy. LED light source chip on board CRI 90 or superior, 4000K or 3000K White tone. Power from 25W up to 32W. Driver included in the three phase track adapter.



## DIVA PLUS

Corpo ottico, anello e braccio pressofusi in lega di alluminio con verniciatura a polveri. Sorgente luminosa a LED chip on board, CRI 90 o superiore, tono luce bianco 4000K o 3000K. Potenze da 20W a 28W. Alimentatore incluso nell'adattatore a scomparsa nel binario a trifase.

Body, ring and arm in powder coated die-cast aluminum alloy. LED light source chip on board CRI 90 or superior, 4000K or 3000K White tone. Power from 20W to 28W. Hidden three phase track adapter driver included.



## DIVA BASE

Corpo ottico e anello pressofusi in lega di alluminio. Braccio in estruso di alluminio con verniciatura a polveri. Sorgente luminosa a LED chip on board CRI 90 o superiore tono luce bianco 4000K o 3000K. Potenze da 32W a 38W. Permette una rotazione di +/- 170° sul piano orizzontale e un'inclinazione di +/- 85° sul piano verticale. Alimentatore elettronico incluso nella base.

Body and ring in die-cast aluminum alloy. Arm in powder coated extruded aluminum. LED light source chip on board CRI 90 or superior, 4000K or 3000K White tone. Power from 32W to 38W. It allows +/- 170° horizontal and +/- 85° vertical adjustment. Driver included.

CE	IP20
LED	RG1
CRI 90	Driver on/off incl.
L80 B10	90° 360°
50000H	Mac Adam 3
⏚	



# DIVA IN

## Z. COLOR

- bianco ragg. / rough white - **32**
- nero ragg. / rough black - **33**
- grigio chiaro / clear grey - **37**
- custom - **99**

## D. OPTIC 12.5° 1

## OPTIC 37° 2

## OPTIC 58° 3

## CRI90 6

## ART FASHION 3 4

## FOOD GOLD 7 MEAT 8 FISH 9

## Y. 4000K 7

## 3000K 8

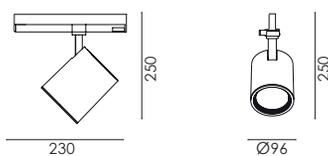

CODICE / CODE	W	LM	FASCIO / BEAM	DRIVER
25 W				
<b>MSA.4464. D 6 Y. Z</b>	25W/230V LED	3450/3290	12.5°/37°/58°	ON/OFF
<b>MSA.4424. D 6 Y. Z</b>	25W/230V LED	3450/3290	12.5°/37°/58°	DALI
<b>MSA.4454. D 6 Y. Z</b>	25W/230V LED	3450/3290	12.5°/37°/58°	CASAMBI
32 W				
<b>MSA.4465. D 6 Y. Z</b>	32W/230V LED	4400/4200	12.5°/37°/58°	ON/OFF
<b>MSA.4425. D 6 Y. Z</b>	32W/230V LED	4400/4200	12.5°/37°/58°	DALI
<b>MSA.4455. D 6 Y. Z</b>	32W/230V LED	4400/4200	12.5°/37°/58°	CASAMBI

## ACCESSORI / ACCESSORIES



**MDI.FC**  
Copertura riflettore satinata.  
Flood satinated Lens.



**MDI.EL**  
Diffusore ellittico.  
Elliptical lens.



**MDI.HC**  
Diffusore a nido d'ape.  
Honeycomb lens.





CE	IP20
LED	RG1
CRI 90	Driver on/off incl.
L80 B10	90° <sup>z</sup> 360° <sup>y</sup>
50000H	Mac Adam 3
⏚	

- 32 - bianco ragg. / rough white
- 33 - nero ragg. / rough black
- 37 - grigio chiaro / clear grey
- 99 - custom

**Z.**  
COLOR

# DIVA PLUS

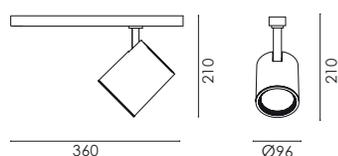

CODICE / CODE	W	LM	FASCIO / BEAM	DRIVER
20 W				
<b>MSA.4474. D 6 Y. Z</b>	20W/230V LED	3170/3000	12.5°/37°/58°	ON/OFF
<b>MSA.4484. D 6 Y. Z</b>	20W/230V LED	3170/3000	12.5°/37°/58°	DALI
28W				
<b>MSA.4475. D 6 Y. Z</b>	28W/230V LED	4320/4140	12.5°/37°/58°	ON/OFF
<b>MSA.4485. D 6 Y. Z</b>	28W/230V LED	4320/4140	12.5°/37°/58°	DALI

**D.**  
OPTIC  
12.5°  
1

OPTIC  
37°  
2

OPTIC  
58°  
3

CRI90  
6

ART  
FASHION  
3  
4

FOOD  
GOLD 7  
MEAT 8  
FISH 9

**Y.**  
4000K  
7

3000K  
8

## ACCESSORI / ACCESSORIES



**MDI.FC**  
Copertura riflettore satinata.  
Flood satined Lens.



**MDI.EL**  
Diffusore ellittico.  
Elliptical lens.



**MDI.HC**  
Diffusore a nido d'ape.  
Honeycomb lens.

CE	IP20
LED	RG1
CRI 90	Driver on/off incl.
L80 B10	90° 360°
50000H	Mac Adam 3



# DIVA BASE

**Z.**  
COLOR

- bianco ragg. / rough white - **32**
- nero ragg. / rough black - **33**
- grigio chiaro / clear grey - **37**
- custom - **99**

**D.**  
OPTIC  
12.5°  
1

OPTIC  
37°  
2

OPTIC  
58°  
3

CRI90  
6

ART  
FASHION  
4

FOOD  
GOLD  
MEAT  
FISH  
9

**Y.**  
4000K  
7

3000K  
8

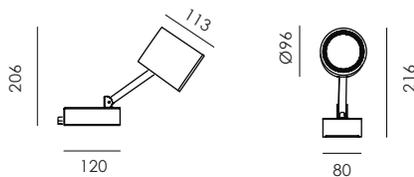

CODICE / CODE	W	LM	FASCIO / BEAM	DRIVER
32 W				
<b>MDI.4835. D 6 Y. Z</b>	32W/230V LED	4400/4200	12.5°/37°/58°	ON/OFF
<b>MDI.4825. D 6 Y. Z</b>	32W/230V LED	4400/4200	12.5°/37°/58°	DALI
<b>MDI.4855. D 6 Y. Z</b>	32W/230V LED	4400/4200	12.5°/37°/58°	CASAMBI
38 W				
<b>MDI.4836. D 6 Y. Z</b>	38W/230V LED	5000/4800	12.5°/37°/58°	ON/OFF
<b>MDI.4826. D 6 Y. Z</b>	38W/230V LED	5000/4800	12.5°/37°/58°	DALI
<b>MDI.4856. D 6 Y. Z</b>	38W/230V LED	5000/4800	12.5°/37°/58°	CASAMBI

## ACCESSORI / ACCESSORIES



**MDI.FC**  
Copertura riflettore satinata.  
Flood satined Lens.



**MDI.EL**  
Diffusore ellittico.  
Elliptical lens.



**MDI.HC**  
Diffusore a nido d'ape.  
Honeycomb lens.





# BINARI TRACKS 230V

Serie di binari dimmerabili 230V. Disponibile in diverse lunghezze e 3 varianti di colore.  
Dimmable 230V tracks available in 3 different lengths and colors.

**Z.**  
COLOR

bianco / white - **02**   
nero / black - **03**   
anodizzato / anodised - **05**



CODICE / CODE	L.MM	DRIVER
<b>MBE.4101.001. Z</b>	1000	dimmerabile dali /dali track
<b>MBE.4101.002. Z</b>	2000	dimmerabile dali /dali track
<b>MBE.4101.003. Z</b>	3000	dimmerabile dali /dali track

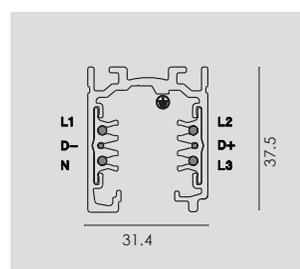

## ACCESSORI / ACCESSORIES



**MBE.4101.210**  
Alimentazione (destra).  
Live end (right).  
**MBE.4101.211**  
Alimentazione (sinistra).  
Live end (left).



**MBE.4101.610. Z**  
Giunto a tre vie (interno).  
3 way coupling (inside).  
**MBE.4101.611. Z**  
Giunto a tre vie (esterno).  
3 way coupling (outside).



**MBE.4101.310**  
Alimentazione centrale.  
Central feed.



**MBE.4101.605**  
Sospensioni 1,5m (coppia).  
Suspension 1,5m (pair).



**MBE.4101.410. Z**  
Giunto lineare.  
Linear joint.



**MBE.4101.700**  
Attacco a soffitto.  
Ceiling mount.



**MBE.4101.510. Z**  
Giunto a due vie (interno).  
2 way coupling (inside).  
**MBE.4101.511. Z**  
Giunto a due vie (esterno).  
2 way coupling (outside).



**MBE.4101.900.Z**  
Testata di chiusura.  
End cap.



# DONNA



La famiglia Donna comprende proiettori LED orientabili 48V e apparecchi a binario lineari adattabili al sistema MULTITRACK 48V.

Ottimi per la loro versatilità e alte prestazioni, sono ideali in contesti espositivi e museali, così come in ambienti domestici e per il retail.

The DONNA family includes 48V adjustable LED projectors and linear track luminaires suitable to MULTITRACK 48V system. Excellent for their versatility and high performance, they are ideal in exhibition, museum as well as domestic and retail contexts.

Abbinalo ai **binari 48V**  
Match with **48V tracks**

pag. 222



Small  
Large  
Infinity







Donna 48V  
**SMALL**



Donna 48V  
**LARGE**



Corpo e anello in lega di alluminio verniciato a polvere. Sorgente luminosa a LED chip on board, CRI 90 o superiore, tono luce bianco 4000K o 3000K. Potenze da 9W a 14W. Alimentatore elettronico incluso nell'adattatore da binario. Disponibile in versione ON-OFF o DALI/PUSH.

Body and ring in powder coated aluminum alloy. LED light source chip on board CRI 90 or superior, 4000K or 3000K White tone. Powers from 9W to 14W. Driver included in the 48V track adapter. Available in ON-OFF or DALI/PUSH version.



Donna 48V  
**INFINITY**

Corpo in lega di alluminio, testate in acciaio, verniciatura a polveri. Diffusore in policarbonato opale o microprismato UGR per il controllo dell'abbagliamento. Tono luce bianco 4000K o 3000K. Potenze da 6W/286mm a 24W/1128mm. Alimentatore elettronico incluso nell'adattatore da binario. Disponibile in versione ON-OFF o DALI/PUSH.

Body in extruded aluminum alloy, end cap in steel, powder coated. Opal or microprismatic diffuser for UGR glare control. LED in 4000K or 3000K white tone, Powers from 6W/286mm up to 24W/1128mm. Driver included in the 48V track adapter. Available in ON-OFF or DALI/PUSH version.



CE	IP20
LED	RG1
CRI 90	48 V
L80 B10	70° 360°
50000H	Corrente Continua
	Direct current

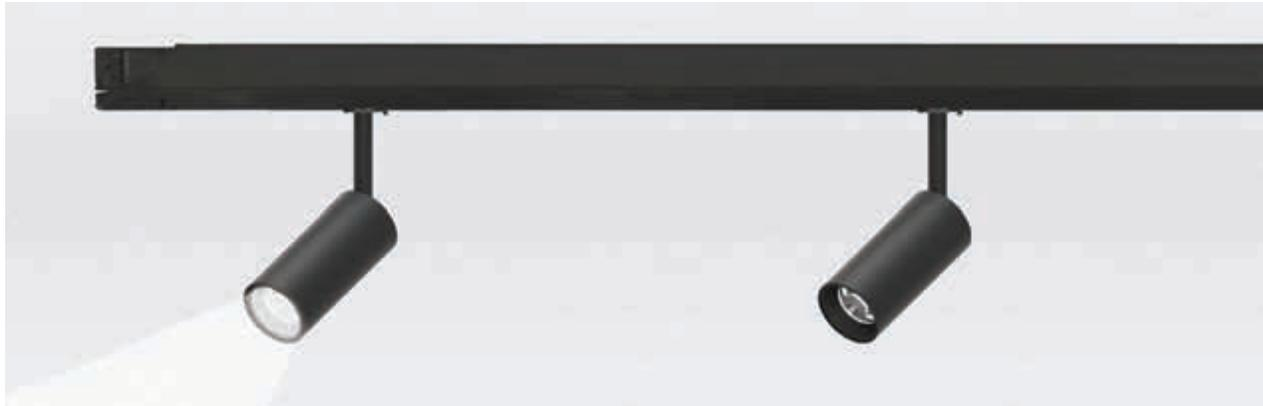

# DONNA 48 V SMALL

COLOR

nero ragg. / rough black - 33

D.  
OPTIC  
20°  
1

OPTIC  
30°  
2

CRI90  
6

Y.  
4000K  
7

3000K  
8

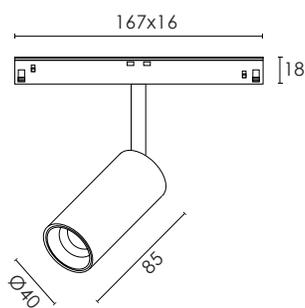

CODICE / CODE	D.MM	W	LM	FASCIO / BEAM	DRIVER
MVI.3703.D 6 Y.33	40	9W/48V	970/950	20°/30°	ON/OFF
MVI.3713.D 6 Y.33	40	9W/48V	970/950	20°/30°	dimmerabile 1-10V

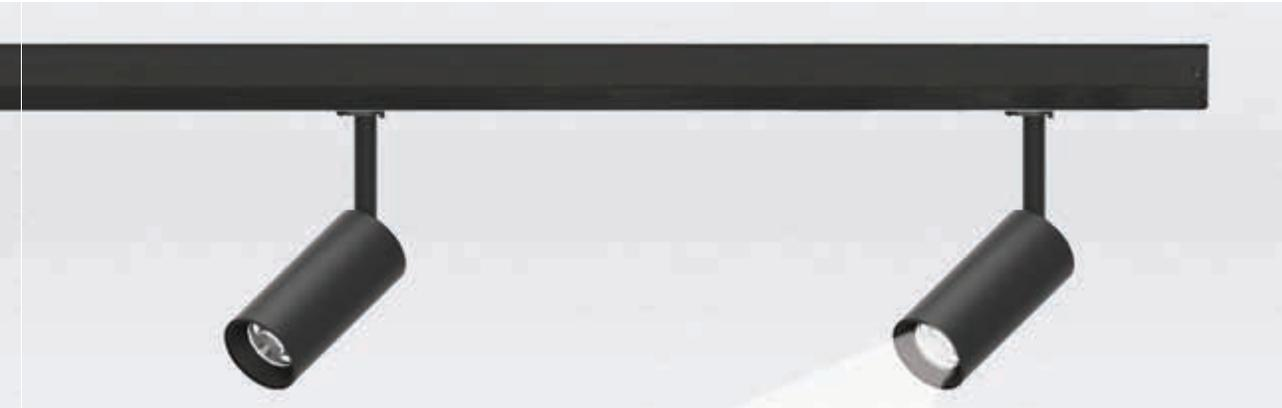

CE	IP20
LED	RG1
CRI 90	48 V
L80 B10	70° 360°
50000H	Corrente Continua
	Direct current

■ 33 - nero ragg. / rough black

COLOR

# DONNA 48 V LARGE

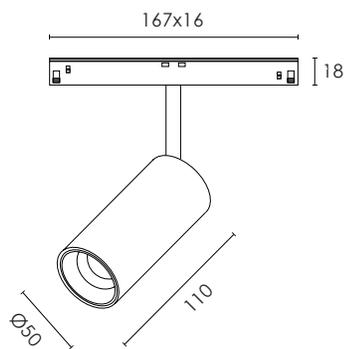

D.  
OPTIC  
12°  
1

OPTIC  
24°  
2

OPTIC  
36°  
3

CRI90  
6

Y.  
4000K  
7

3000K  
8

CODICE / CODE	D.MM	W	LM	FASCIO / BEAM	DRIVER
MVI.3705.D 6 Y.33	50	14W/48V	1370/1350	12°/24°/36°	ON/OFF
MVI.3715.D 6 Y.33	50	14W/48V	1370/1350	12°/24°/36°	dimmerabile 1-10V
MVI.3725.D 6 Y.33	50	14W/48V	1370/1350	12°/24°/36°	dimmerabile DALI

CE	IP20
LED	RG1
CRI 90	48 V
L80 B10	50000H
III	Corrente Continua
	Direct current

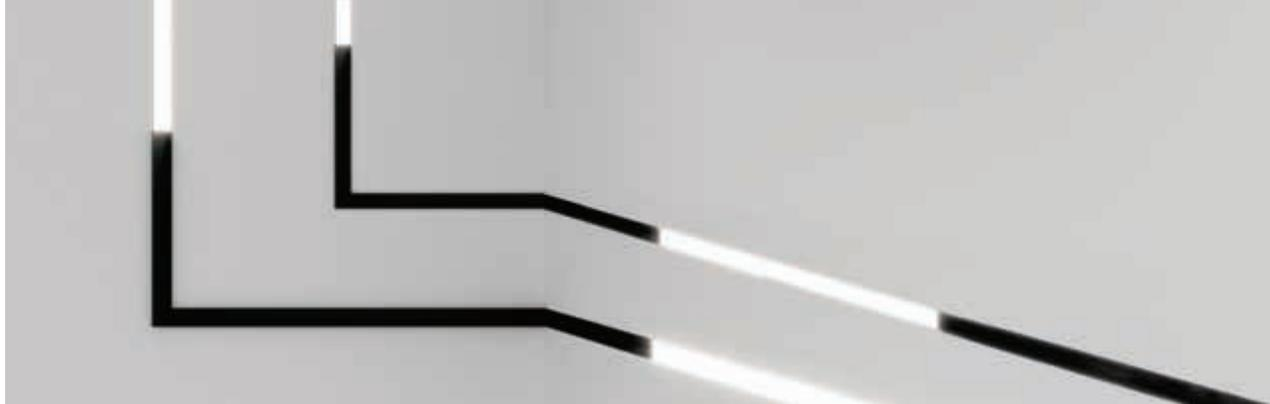

# DONNA 48 V

## INFINITY

COLOR

nero ragg. / rough black - 33 ■

D.  
OPAL  
0

MICRO  
PRISMATIC  
9

CRI90  
6

Y.  
4000K  
7

3000K  
8

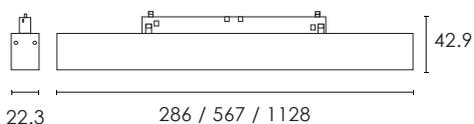

CODICE / CODE	L.MM	W	LM	DRIVER
MVI.6703.D 6 Y. 33	286	6W/48V	810/740	ON/OFF
MVI.6704.D 6 Y. 33	567	12W/48V	1600/1480	ON/OFF
MVI.6724.D 6 Y. 33	567	12W/48V	1600/1480	dimmerabile DALI
MVI.6705.D 6 Y. 33	1128	24W/48V	3200/2970	ON/OFF
MVI.6725.D 6 Y. 33	1128	24W/48V	3200/2970	dimmerabile DALI

ABBINALO A / PAIR IT WITH

BINARIO C  
TRACK C

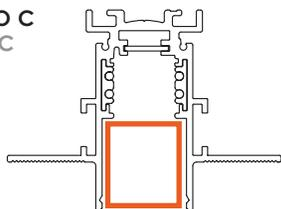

BINARIO D  
TRACK D

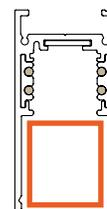

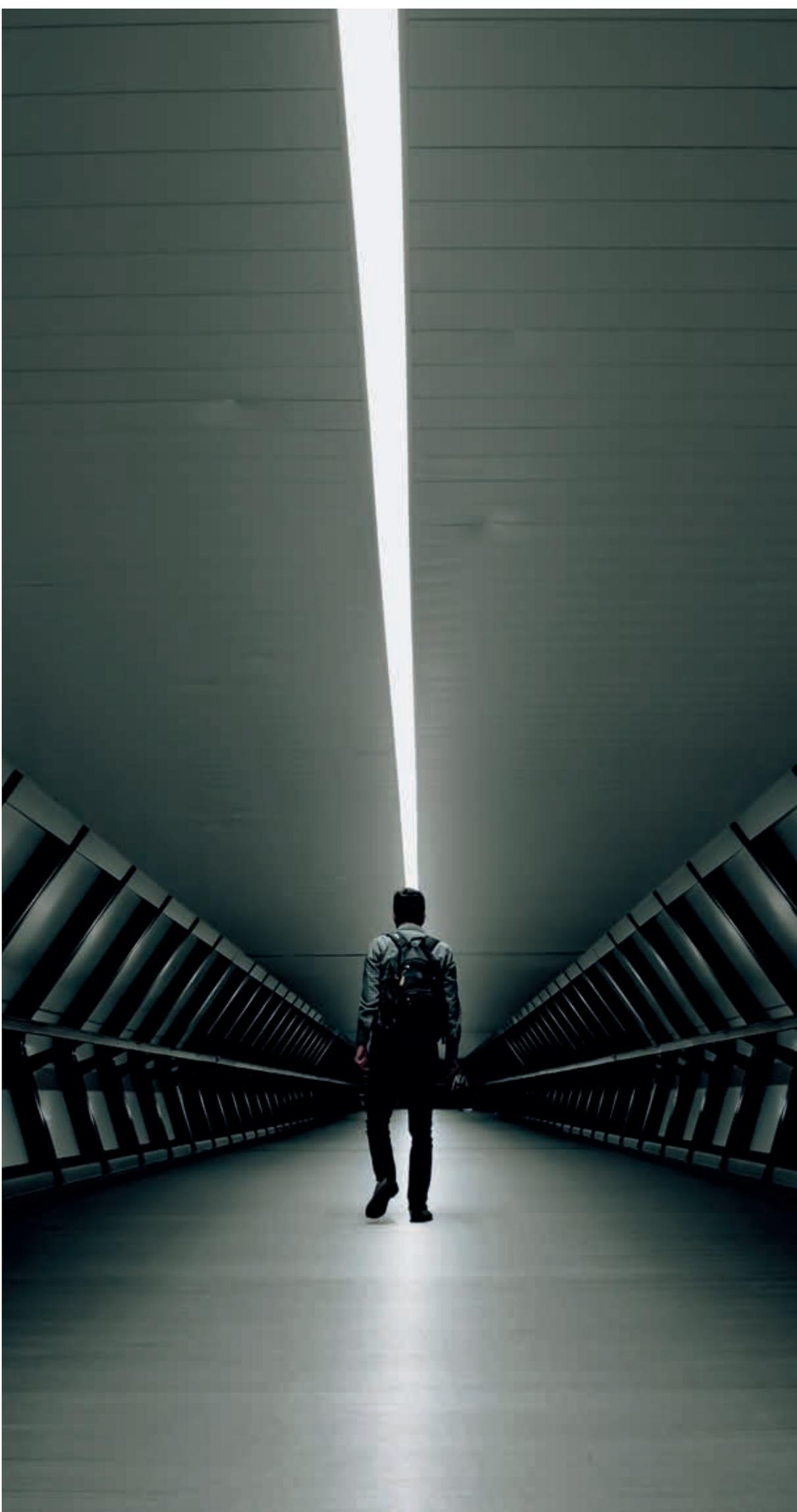

CE	IP20
DALI	Corrente Continua
	Direct current

# BINARI TRACKS 48V

Serie di binari MULTI TRACK 48V. Disponibile in diverse lunghezze per rispondere alle diverse richieste di utilizzo.

48V MULTI TRACKS are available in 3 different lengths for different kind of installations.

COLOR

nero / black - 03

## Scegli il tuo binario Choose your track

Donna  
small  
large



### A. Binario standard 48V. Standard track 48V.

CODICE / CODE	L
<b>MBL.4102.011</b>	L.1m
<b>MBL.4102.012</b>	L.2m
<b>MBL.4102.013</b>	L.3m

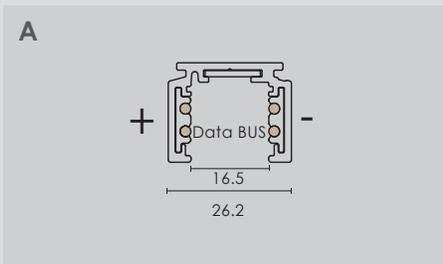

### B. Binario basic 48V. Basic track 48V.

CODICE / CODE	L
<b>MBL.4102.061</b>	L.1m
<b>MBL.4102.062</b>	L.2m
<b>MBL.4102.063</b>	L.3m

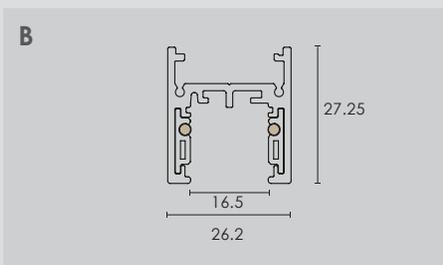

Donna  
Infinity



### C. Binario H 48V. Track H 48V.

CODICE / CODE	L
<b>MBL.4102.021</b>	L.1m
<b>MBL.4102.022</b>	L.2m
<b>MBL.4102.023</b>	L.3m

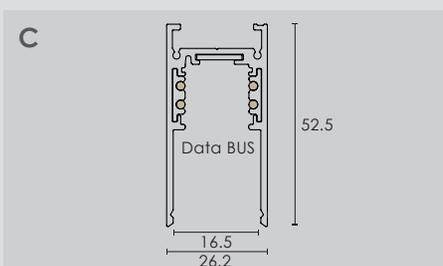

### D. Binario da incasso trimless 48V. Trimless recessed track 48V.

CODICE / CODE	L
<b>MBL.4102.051</b>	L.1m
<b>MBL.4102.052</b>	L.2m
<b>MBL.4102.053</b>	L.3m

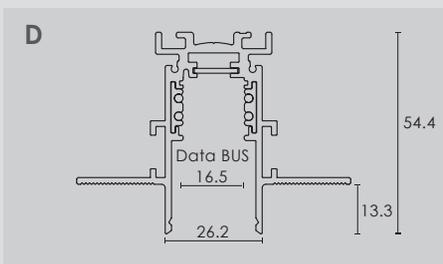

# COMPLETA IL TUO MODULO

## COMPLETE YOUR MODULE

### Tappo di chiusura

End cap

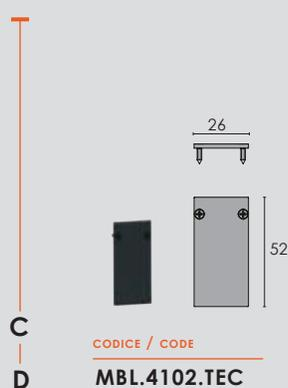
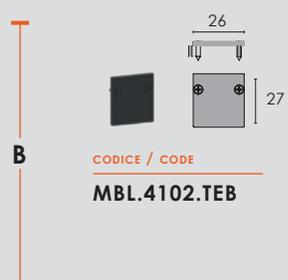
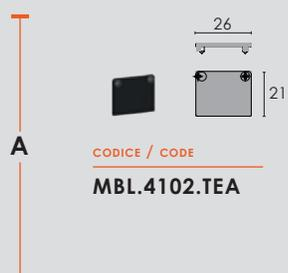

### Kit di sospensione

Suspension kit (pair)

COPPIA - PAIR

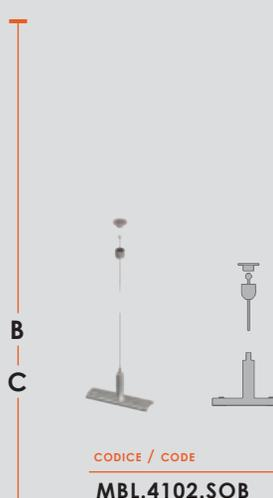

### Alimentazione 48 V

Live end 48V



### Kit Alimentazione per binari 48V

Power supply kit for 48V tracks



CODICE / CODE	W
<b>MBL.RA-1</b>	70W ON/OFF
<b>MBL.RA-2</b>	150W ON/OFF
<b>MBL.RA-2-A2</b>	150W DALI

### Giunto passante 48V

Linear joint 48V



### Giunto a L 48V

L feed 48V

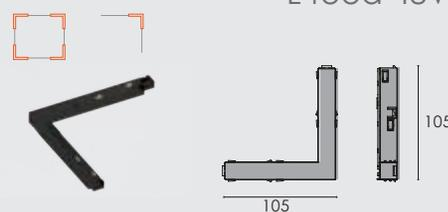

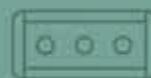

# DOWNLIGHTS



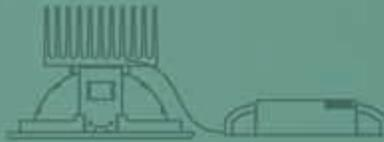
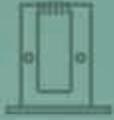
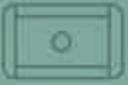

**Indoor**

# FLUX



Flux è una collezione di apparecchi da incasso dalle forme essenziali e razionali. La luce prodotta risulta diffusa e gradevole, e la sua versatilità lo rende adatto ad ambienti dalle diverse dimensioni.

Flux is a collection of recessed lights with essential and rational shapes. The light produced is diffuse and pleasant, and its versatility makes it suitable for environments of different sizes.



## FLUX

Cornice in pressofusione di alluminio verniciato a polveri. Struttura in lamiera di acciaio e ottica in alluminio purissimo e ad alto rendimento.

Vetro di protezione temperato, interamente o parzialmente sabbato.

Frame in powder-coated die-cast aluminium. Steel sheet structure and high performance pure aluminium optics.

Tempered protection glass with partial or frosted finish.

CE	IP43
<b>LED</b>	<b>RG1</b>
CRI 80/90	Driver on/off incl.
L80 B10	Mac Adam 3
50000H	



# FLUX

**Z.**  
**COLOR**

- bianco / white - **02**
- nero / black - **03**
- grigio chiaro opaco / clear matt grey - **37**
- custom - **99**

**D.**  
PARZIALMENTE  
SABBIATO  
PARTIALLY  
SANDED **0**

**SABBIATO  
SANDED **1****

**X.**  
**CRI80 **5****

**CRI90 **6****

**4000K **7****

**3000K **8****

**DIM**  
**1-10V **A1****

**DALI **A2****

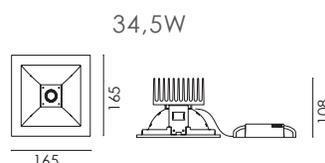
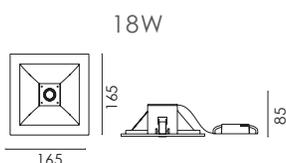

COD. ON/OFF	L.MM	W	K	LM
SMALL				
<b>JEE.5309. D X 7. Z</b>	165x165	18W/230V LED	4000K	2700
<b>JEE.5309. D X 8. Z</b>	165x165	18W/230V LED	3000K	2550
<b>JEE.5310. D X 7. Z</b>	165x165	34,5W/230V LED	4000K	4400
<b>JEE.5310. D X 8. Z</b>	165x165	34,5W/230V LED	3000K	4200

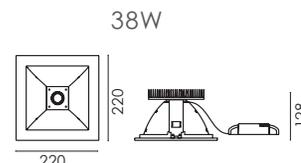
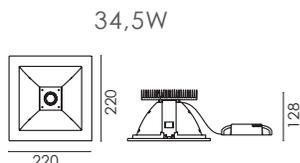
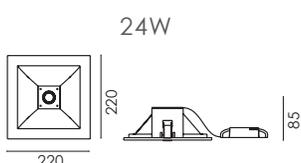

COD. ON/OFF	L.MM	W	K	LM
LARGE				
<b>JEE.5311. D X 7. Z</b>	220x220	24W/230V LED	4000K	3600
<b>JEE.5311. D X 8. Z</b>	220x220	24W/230V LED	3000K	3450
<b>JEE.5312. D X 7. Z</b>	220x220	34,5W/230V LED	4000K	5000
<b>JEE.5312. D X 8. Z</b>	220x220	34,5W/230V LED	3000K	4800
<b>JEE.5313. D X 7. Z</b>	220x220	38W/230V LED	4000K	5300
<b>JEE.5313. D X 8. Z</b>	220x220	38W/230V LED	3000K	5050

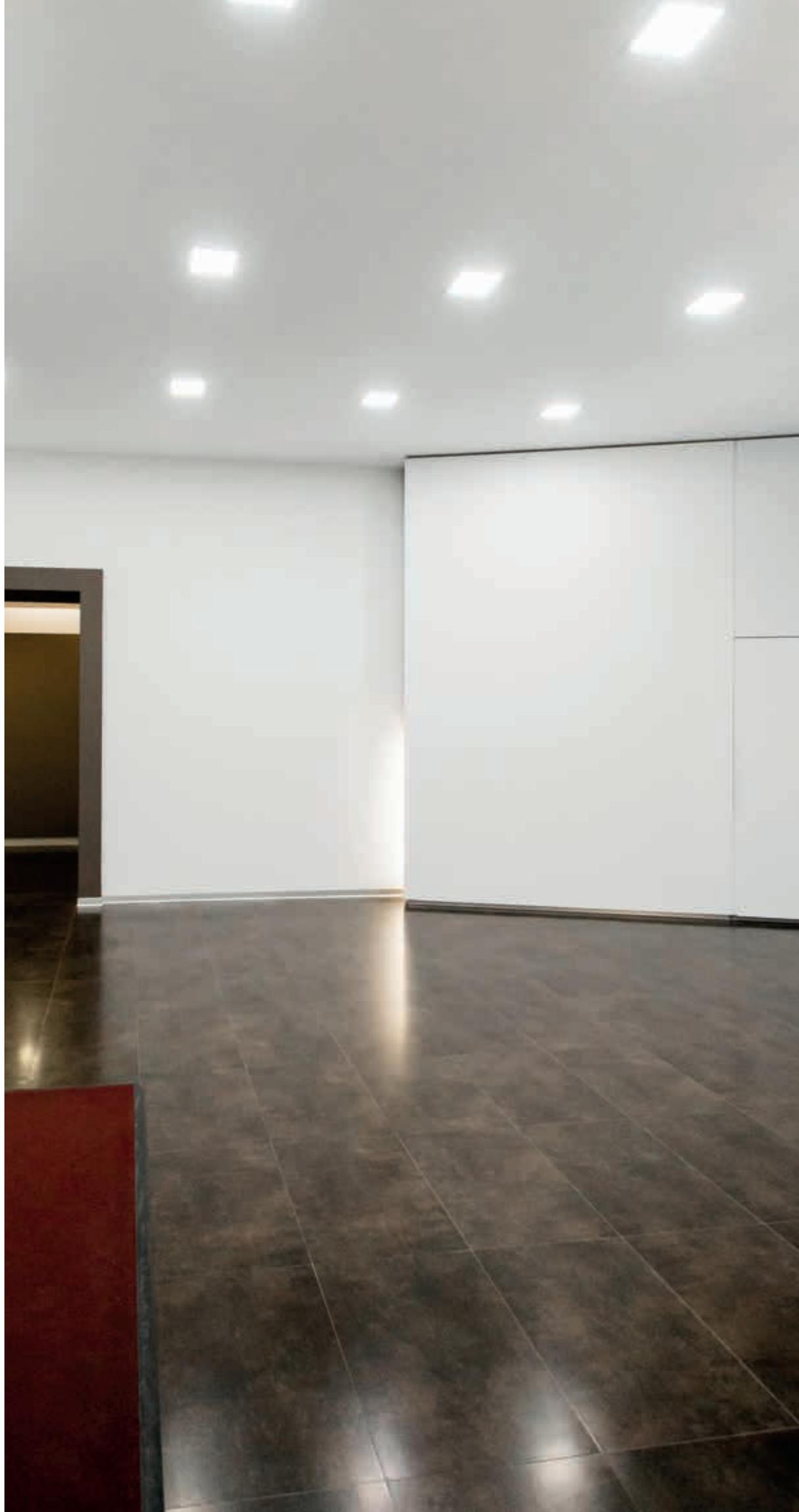

# MODO



Modo è una collezione di apparecchi da incasso che grazie al suo caratteristico gruppo ottico orientabile risulta l'ideale per spazi espositivi e commerciali. La luce potente e concentrata e le numerose varianti rendono Modo LED estremamente versatile, specialmente grazie all'orientabilità di 30° su due assi.

Modo is a collection of recessed lights which is ideal for exhibition and commercial spaces thanks to its characteristic swivelling optical unit. Powerful, concentrated light and numerous variants make Modo LED extremely versatile, especially thanks to the fact that it can be adjusted by 30° in two axes.



## MODO

La struttura degli apparecchi è in alluminio pressofuso verniciato. Disponibile anche nella versione senza cornice. Incassi ad 1/2/3/4 lampade, con riflettore per fascio da 24° o 40°. Orientabile di 30° su due assi.

The structure of the lights is made of painted die-cast aluminium. Frame and frameless version. Available with the 1/2/3/4 lamps versions, 24 ° or 40 ° beam angle. Optical group that can be oriented at 30° on two axis.

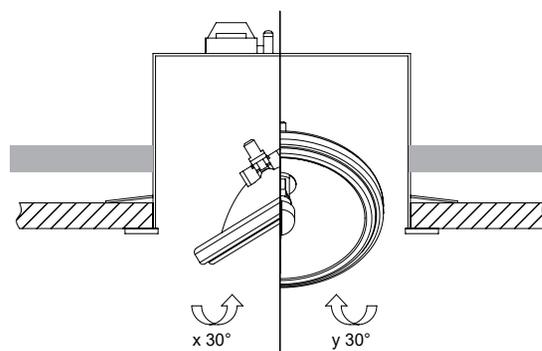

CE	IP20
LED	RG1
CRI 80/90	Driver on/off incl.
L80 B10	Mac Adam 3
50000H	30°
⏚	



# MODO 1 LIGHT

MODO 1 LIGHT

**Z.**  
COLOR

- bianco ragg. / rough white - **32**
- nero ragg. / rough black - **33**
- grigio chiaro / clear grey - **37**
- custom - **99**

**D.**  
24°  
1

40°  
2

**X.**  
CRI80  
5

CRI90  
6

**Y.**  
4000K  
7

3000K  
8

**DIM**  
1-10V  
A1

DALI  
A2

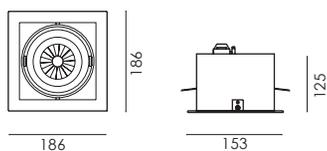

↳ 155x155 ◀  
Cutout / Foro: 155x155mm

MODO FRAMELESS 1 LIGHT

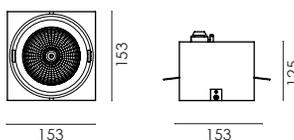

↳ 155x155 ◀  
Cutout / Foro: 155x155mm

**COD. ON/OFF**

**L.**

**L.MM**

**W**

**LM**

MODO 1 LIGHT

<b>MOD.5211.D X Y. Z</b>	1 light	186x186	16W/230V COB LED	1350/1250
<b>MOD.5221.D X Y. Z</b>	1 light	186x186	23W/230V COB LED	1950/1850
<b>MOD.5231.D X Y. Z</b>	1 light	186x186	33W/230V COB LED	3600/3300

MODO FRAMELESS 1 LIGHT

<b>MOB.5211.D X Y. Z</b>	1 light	186x186	16W/230V COB LED	1350/1250
<b>MOB.5221.D X Y. Z</b>	1 light	186x186	23W/230V COB LED	1950/1850
<b>MOB.5231.D X Y. Z</b>	1 light	186x186	33W/230V COB LED	3600/3300





CE	IP20
LED	RG1
CRI 80/90	Driver on/off incl.
L80 B10	Mac Adam 3
50000H	30°
⏚	

- 32 - bianco ragg. / rough white
- 33 - nero ragg. / rough black
- 37 - grigio chiaro / clear grey
- 99 - custom

**Z.**  
COLOR

# M O D O

## 2 LIGHTS

MODO 2 LIGHT

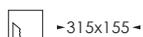
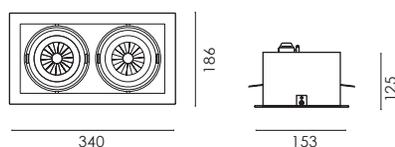

Cutout / Foro: 315x155mm

MODO FRAMELESS 2 LIGHT

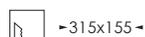
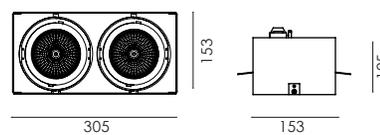

Cutout / Foro: 315x155mm

**COD. ON/OFF**

**L.**

**L.MM**

**W**

**LM**

MODO 2 LIGHTS

<b>MOD.5212.D X Y. Z</b>	2 light	340x186	2x16W/230V COB LED	2700/2500
<b>MOD.5222.D X Y. Z</b>	2 light	340x186	2x23W/230V COB LED	3900/3700
<b>MOD.5232.D X Y. Z</b>	2 light	340x186	2x33W/230V COB LED	7200/6600

MODO FRAMELESS 2 LIGHTS

<b>MOB.5212.D X Y. Z</b>	2 light	340x186	2x16W/230V COB LED	2700/2500
<b>MOB.5222.D X Y. Z</b>	2 light	340x186	2x23W/230V COB LED	3900/3700
<b>MOB.5232.D X Y. Z</b>	2 light	340x186	2x33W/230V COB LED	7200/6600

**D.**

24°  
1

40°  
2

**X.**

CRI80  
5

CRI90  
6

**Y.**

4000K  
7

3000K  
8

**DIM**

1-10V  
A1

DALI  
A2

CE	IP20
LED	RG1
CRI 80/90	Driver on/off incl.
L80 B10	Mac Adam 3
50000H	30%



# MODO 3 LIGHTS

<b>Z.</b> COLOR	bianco ragg. / rough white - <b>32</b>	<input type="checkbox"/>
	nero ragg. / rough black - <b>33</b>	<input type="checkbox"/>
	grigio chiaro / clear grey - <b>37</b>	<input type="checkbox"/>
	custom - <b>99</b>	<input type="checkbox"/>

**D.**  
24°  
1

40°  
2

**X.**  
CRI80  
5

CRI90  
6

**Y.**  
4000K  
7

3000K  
8

**DIM**  
1-10V  
A1

DALI  
A2

MODO 3 LIGHTS

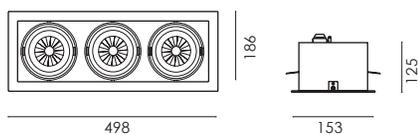

Cutout / Foro: 475x155mm

MODO FRAMELESS 3 LIGHTS

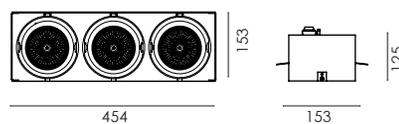

Cutout / Foro: 475x155mm

COD. ON/OFF	L.	L.MM	W	LM
MODO 3 LIGHTS				
<b>MOD.5213.D X Y. Z</b>	3 light	498x186	3x16W/230V COB LED	4050/3750
<b>MOD.5223.D X Y. Z</b>	3 light	498x186	3x23W/230V COB LED	5850/5550
<b>MOD.5233.D X Y. Z</b>	3 light	498x186	3x33W/230V COB LED	10800/10200
MODO FRAMELESS 3 LIGHTS				
<b>MOB.5213.D X Y. Z</b>	3 light	498x186	3x16W/230V COB LED	4050/3750
<b>MOB.5223.D X Y. Z</b>	3 light	498x186	3x23W/230V COB LED	5850/5550
<b>MOB.5233.D X Y. Z</b>	3 light	498x186	3x33W/230V COB LED	10800/10200



CE	IP20
LED	RG1
CRI 80/90	Driver on/off incl.
L80 B10	Mac Adam 3
50000H	30°
⏚	

- Z. COLOR**
- 32 - bianco ragg. / rough white
  - 33 - nero ragg. / rough black
  - 37 - grigio chiaro / clear grey
  - 99 - custom

# MODO 4 LIGHTS

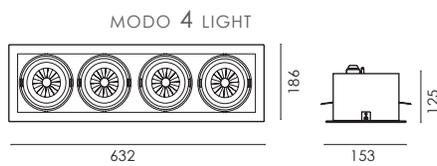

→605x155←  
Cutout / Foro: 605x155mm

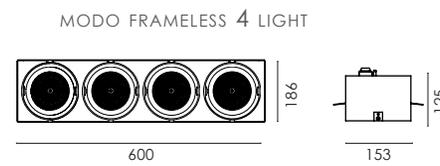

→605x155←  
Cutout / Foro: 605x155mm

COD. ON/OFF	L.	L.MM	W	LM
MODO 4 LIGHTS				
<b>MOD.5214.D X Y. Z</b>	4 light	632x186	4x16W/230V COB LED	5400/5000
<b>MOD.5224.D X Y. Z</b>	4 light	632x186	4x23W/230V COB LED	7800/7400
<b>MOD.5234.D X Y. Z</b>	4 light	632x186	4x33W/230V COB LED	14400/13600
MODO FRAMELESS 4 LIGHTS				
<b>MOB.5214.D X Y. Z</b>	4 light	632x186	4x16W/230V COB LED	5400/5000
<b>MOB.5224.D X Y. Z</b>	4 light	632x186	4x23W/230V COB LED	7800/7400
<b>MOB.5234.D X Y. Z</b>	4 light	632x186	4x33W/230V COB LED	14400/13600

- D.**  
24°  
1
- 40°  
2
- X.**  
CRI80  
5
- CRI90  
6
- Y.**  
4000K  
7
- 3000K  
8
- DIM**  
1-10V  
A1
- DALI  
A2





# AIR

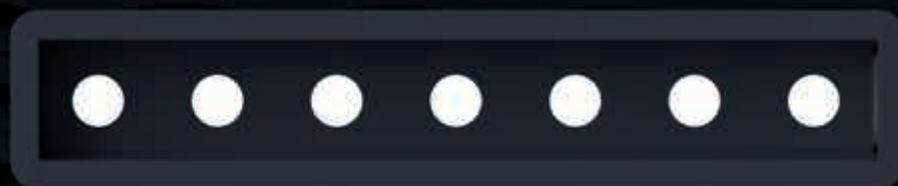

AIR è un sistema a sorgenti multiple perfetto per l'illuminazione di negozi e uffici. Grazie al suo design minimale e alle sue dimensioni ridotte può essere inserito anche in contesti abitativi dallo stile moderno e si adatta a tutti gli ambienti, creando un effetto abbagliamento ridotto.

AIR is a multi-source system that is perfect for shop and office lighting. Thanks to its minimalist design and small dimensions, it can also be used in modern living spaces and fits into any environment, creating a reduced glare effect.



## AIR

Serie di apparecchi da incasso per interni. Corpo in alluminio con verniciatura raggrinzante. Disponibile in 4 modelli standard: dal più piccolo a 1 LED fino a una sezione da 7 LED. Lenti a 25° o 60°. Facilmente personalizzabile.

Alimentabile a 350 o 500 mA. Alimentatore escluso.

Series of recessed luminaires for indoor use. Realized in coated aluminium. Available in 4 standard models: from the smallest 1 LED up to a 7 LED section. 25° or 60° lenses. Easily customisable.

Air can be supplied at 350 or 500 mA. Driver excluded.

CE	IP20
LED	RG1
CRI 80/90	50000H
L80 B10	Mac Adam 3

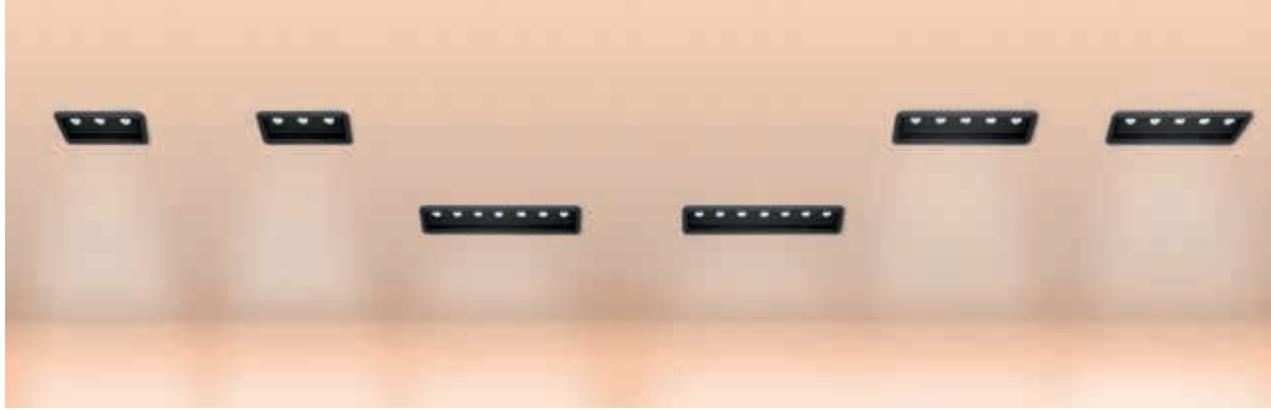

# AIR

## Z. COLOR

- bianco ragg. / rough white - **32**
- nero ragg. / rough black - **33**
- grigio chiaro / clear grey - **37**
- custom - **99**

OPTIC  
25° **2**

OPTIC  
60° **6**

X.  
CRI80  
**5**

CRI90  
**6**

Y.  
4000K  
**7**

3000K  
**8**

DIM  
1-10V  
**A1**

DALI  
**A2**

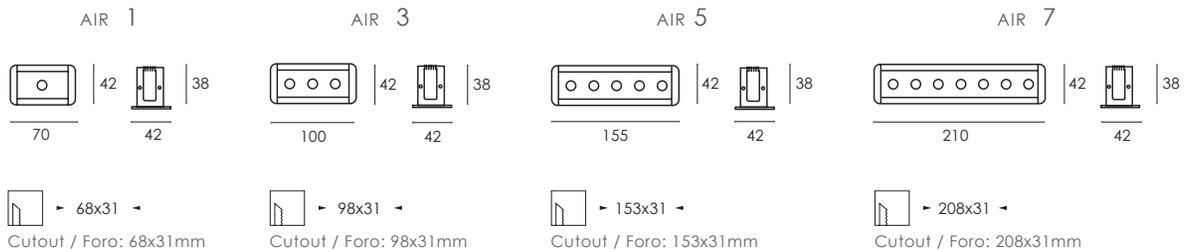

COD. ON/OFF	D.MM	W	FASCIO / BEAM	LM
AIR 1				
JAI.5261. <b>2 X Y. Z</b>	70x42	1.2/2W/230V LED 350/500mA	25°	108/93
JAI.5261. <b>6 X Y. Z</b>	70x42	1.2/2W/230V LED 350/500mA	60°	108/93
AIR 3				
JAI.5263. <b>2 X Y. Z</b>	100x42	3x1.2/2W/230V LED 350/500mA	25°	323/278
JAI.5263. <b>6 X Y. Z</b>	100x42	3x1.2/2W/230V LED 350/500mA	60°	323/278
AIR 5				
JAI.5265. <b>2 X Y. Z</b>	155x42	5x1.2/2W/230V LED 350/500mA	25°	538/462
JAI.5265. <b>6 X Y. Z</b>	155x42	5x1.2/2W/230V LED 350/500mA	60°	538/462
AIR 7				
JAI.5267. <b>2 X Y. Z</b>	210x42	7x1.2/2W/230V LED 350/500mA	25°	756/650
JAI.5267. <b>6 X Y. Z</b>	210x42	7x1.2/2W/230V LED 350/500mA	60°	756/650

## ACCESSORI / ACCESSORIES



**AAA.TRSL00**  
Driver IP20 3W/350mA.



**AAA.TRSL41**  
Driver IP20 6W/500mA.



**AAA.TRSL05**  
Driver IP20 19W/350mA.



**AAA.TRSL45**  
Driver IP20 20W/500mA.





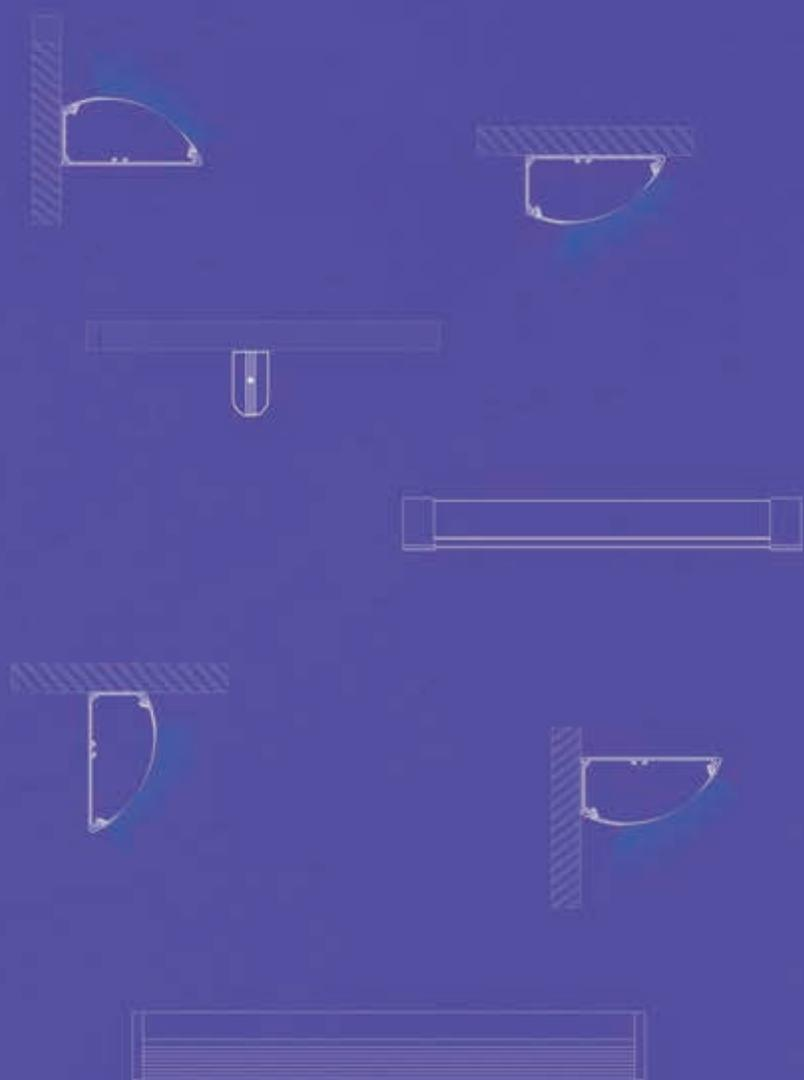

# LUCI D'AMBIENTE

## Ambient lights

**Indoor**

# F - S E R I E S

F-44

Appliques da parete che hanno da sempre contraddistinto la nostra produzione. Per un'illuminazione pratica e funzionale trovano collocazione soprattutto negli spazi in cui l'alto livello di umidità richiede un grado di protezione maggiorato, ad esempio per illuminazione di cucine e bagni.

Wall fittings that have always distinguished our production. For practical and functional lighting, it is especially suitable for spaces where the high level of humidity requires an increased degree of protection, for example kitchens and bathrooms.



F-55







## F-44

Corpo in lega di alluminio estruso, testate in tecnopolimero, verniciatura a polveri. Diffusore in policarbonato opale. Tono luce bianco 4000K o 3000K, Potenze da 14W/640mm a 28W/1250mm. Alimentatore elettronico e diffusore inclusi. Disponibile in versione con sensore di presenza

Structure in powder coated aluminium alloy, end caps in techno polymer . Opal polycarbonate diffuser. LED in 4000K or 3000K white tone. Powers from 14W/640mm up to 28W/1250mm. Electronic driver and diffuser included. Motion sensors version available.



## F-55

Corpo in lega di alluminio estruso, testate in tecnopolimero, verniciatura a polveri. Diffusore in policarbonato opale. Tono luce bianco 4000K o 3000K, Potenze da 14W/580mm a 28W/1180mm. Alimentatore elettronico e diffusore inclusi.

Structure in powder coated aluminium alloy, end caps in techno polymer . Opal polycarbonate diffuser. LED in 4000K or 3000K white tone. Powers from 14W/580mm up to 28W/1180mm. Electronic driver and diffuser included. Motion sensors version available.

CE	IP44
<b>LED</b>	<b>RG1</b>
CRI 80/90	Driver on/off incl.
L80 B10	Mac Adam 3
	50000H
<b>850°</b>	



# F - 4 4

COLOR

bianco/white -02

- X.**  
CRI80  
**5**
- CRI90  
**6**
- 4000K  
**7**
- 3000K  
**8**
- DIM.**  
1-10V  
**A1**
- DALI  
**A2**

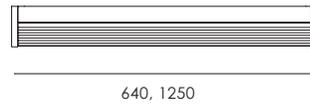
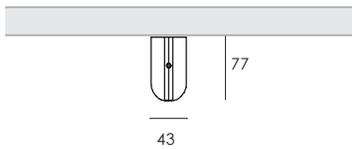

COD. ON/OFF	L.MM	W	K	LM
<b>F44.3211.0 X 7. 02</b>	640	14W/230V LED	4000K	1585
<b>F44.3211.0 X 8. 02</b>	640	14W/230V LED	3000K	1502
<b>F44.3213.0 X 7. 02</b>	1250	28W/230V LED	4000K	3170
<b>F44.3213.0 X 8. 02</b>	1250	28W/230V LED	3000K	3004

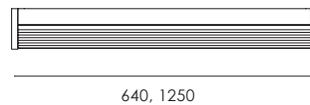
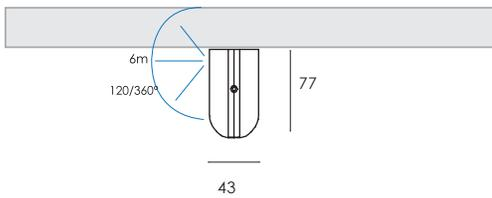

COD. ON/OFF	L.MM	W	K	LM
CON SENSORE DI PRESENZA/ WITH PRESENCE SENSOR				
<b>F44.3211MS.0 X 7. 02</b>	640	14W/230V LED	4000K	1585
<b>F44.3211MS.0 X 8. 02</b>	640	14W/230V LED	3000K	1502
<b>F44.3213MS.0 X 7. 02</b>	1250	28W/230V LED	4000K	3170
<b>F44.3213MS.0 X 8. 02</b>	1250	28W/230V LED	3000K	3004





CE	IP44
LED	RG1
CRI 80/90	Driver on/off incl.
L80 B10	Mag Adam 3
	50000H
850°	

02- bianco/white

COLOR

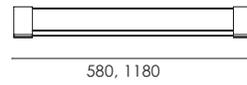
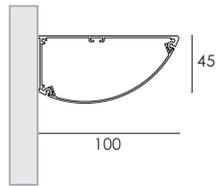

# F - 5 5

X.  
CRI80  
5

CRI90  
6

4000K  
7

3000K  
8

DIM.  
1-10V  
A1

DALI  
A2

COD. ON/OFF	L.MM	W	K	LM
F55.5015.0 X 7. 02	580	14W/230V LED	4000K	1585
F55.5015.0 X 8. 02	580	14W/230V LED	3000K	1502
F55.5017.0 X 7. 02	1180	28W/230V LED	4000K	3170
F55.5017.0 X 8. 02	1180	28W/230V LED	3000K	3004





PROFILI PER  
STRIP LED



**TAPELIGHT  
PROFILES**



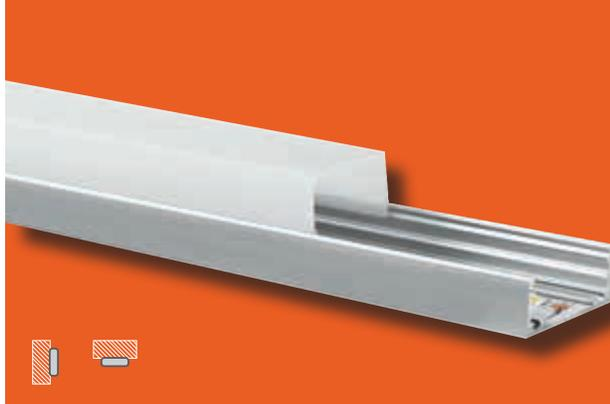

Zero Surface profilo da superficie. Disponibile in barre da 2m e 3m. Adatto solo per Strip LED da 6-10mm.

Zero Surface profile. Available in 2m and 3m lengths. Suitable for 6-10mm tapelight only.



# ZERO SURFACE

COLOR

bianco/white -02   
anodizzato/anodized -05

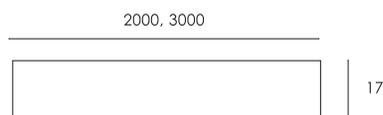
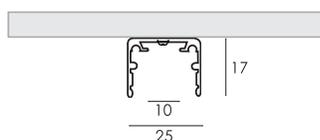

CODICE / CODE	L.MM	COLORE/ COLOR	PREZZO / PRICE
003.023.2000.05	2000	anodizzato / anodised	€25,30
003.023.2000.02	2000	bianco / white	€32,90
003.023.3000.05	3000	anodizzato / anodised	€38,00
003.023.3000.02	3000	bianco / white	€48,80

CODICE / CODE	L.MM	DIFFUSORE / DIFFUSER	PREZZO / PRICE
PIANO/ FLAT			



005.023.2001.22	2000	opalino/ opal	€10,30
005.023.3001.22	3000	opalino/ opal	€15,70

TONDO/ ROUND



005.023.2002.22	2000	opalino / opal	€14,90
005.023.2002.23	2000	acidato / frosted	€14,90
005.023.3002.22	3000	opalino / opal	€22,40
005.023.3002.23	3000	acidato / frosted	€22,40

QUADRO/ SQUARE



005.023.2003.22	2000	opalino / opal	€17,80
005.023.2003.23	2000	acidato / frosted	€17,80
005.023.3003.22	3000	opalino / opal	€27,30
005.023.3003.23	3000	acidato / frosted	€27,30

## ACCESSORI / ACCESSORIES

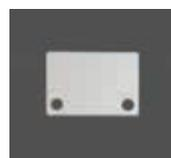

**002.023.8020**  
Testata piano.  
Flat end cap.

€ 3,50



**002.023.8021**  
Testata tonda.  
Round end cap.

€ 3,50



**002.023.8022**  
Testata quadra.  
Square end cap.

€ 3,50

Base-1 profilo da superficie. Disponibile in barre da 2m e 3m. Adatto solo per Strip LED da 6-10mm.  
 Base-1 surface profile. Available in 2m and 3m lengths. Suitable for 6-10mm tapelight only.



- 02- bianco/white
- 05- anodizzato/ anodized

COLOR

# BASE 1

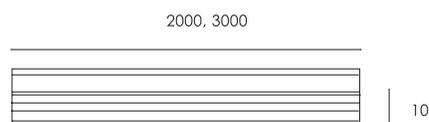
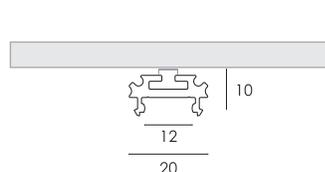

CODICE / CODE	L.MM	COLORE/ COLOR	PREZZO / PRICE
003.024.2000.05	2000	anodizzato / anodised	€ 18,30
003.024.2000.02	2000	bianco / white	€26,00
003.024.3000.05	3000	anodizzato / anodised	€ 27,60
003.024.3000.02	3000	bianco / white	€ 38,40

CODICE / CODE	L.MM	DIFFUSORE / DIFFUSER	PREZZO / PRICE
PIANO/ FLAT			
005.031.2001.22	2000	opalino/ opal	€11,90
005.031.3001.22	3000	opalino/ opal	€18,00
FASCIO STRETTO/ NARROW BEAM			
005.024.2003.23	2000	trasparente / clear	€14,90
005.024.3003.23	3000	trasparente / clear	€22,40



## ACCESSORI / ACCESSORIES

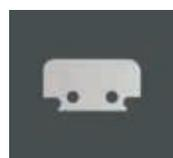

**002.024.8013**  
 Testata piano.  
 Flat end cap.

€ 2,50



**002.024.8021**  
 Testata fascio stretto.  
 Narrow beam endcap.

€ 2,50



**032.024.0001**  
 Clip di fissaggio.  
 Fixing clip.

€ 0,50



Base 3 profilo da plafone. Disponibile in barre da 2m e 3m. Adatto solo per Strip LED da 6-10mm. Altezza minimale di solo 11,3 mm.

Base 3 surface profile. Available in 2m and 3m lengths. Suitable for 6-10mm tapelight only. Height of the profile is only 11.3mm. It is almost invisible and minimal. Easy installation.

# BASE 3

COLOR

bianco/white -02   
anodizzato/anodized -05

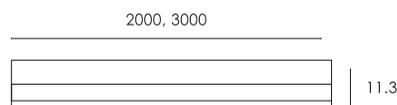

CODICE / CODE	L.MM	COLORE/ COLOR	PREZZO / PRICE
003.037.2000.05	2000	anodizzato / anodised	€22,70
003.037.2000.02	2000	bianco / white	€30,40
003.037.3000.05	3000	anodizzato / anodised	€33,50
003.037.3000.02	3000	bianco / white	€44,40

CODICE / CODE	L.MM	DIFFUSORE / DIFFUSER	PREZZO / PRICE
PIANO/ FLAT			
 005.023.2001.22	2000	opalino / opal	€10,30
005.023.3001.22	3000	opalino / opal	€15,70

CODICE / CODE	L.MM	DIFFUSORE / DIFFUSER	PREZZO / PRICE
TONDO/ ROUND			
 005.023.2002.22	2000	opalino / opal	€14,90
005.023.2002.23	2000	acidato / frosted	€14,90
005.023.3002.22	3000	opalino / opal	€22,40
005.023.3002.23	3000	acidato / frosted	€22,40

CODICE / CODE	L.MM	DIFFUSORE / DIFFUSER	PREZZO / PRICE
QUADRO/ SQUARE			
 005.023.2003.22	2000	opalino / opal	€17,80
005.023.2003.23	2000	acidato / frosted	€17,80
005.023.3003.22	3000	opalino / opal	€27,30
005.023.3003.23	3000	acidato / frosted	€27,30

## ACCESSORI / ACCESSORIES

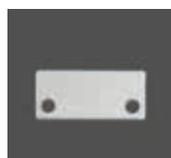

002.037.8020  
Testata piano.  
Flat end cap.

€ 3,50



002.037.8022  
Testata quadra.  
Square end cap.

€ 3,50



002.037.8021  
Testata tonda.  
Round end cap.

€ 3,50



032.024.0001  
Clip di fissaggio.  
Fixing clip.

€ 0,50

Grado angolare profilo da soffitto e parete.  
Disponibile in barre da 2m e 3m. Adatto solo per  
Strip LED da 6-10mm.

Grado surface profile. Available in 2m and 3m  
lengths. Suitable for 6-10mm tapelight only.



- 02- bianco/white
- 05- anodizzato/ anodized

COLOR

# GRADO

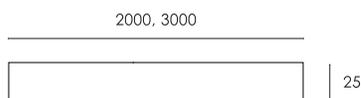
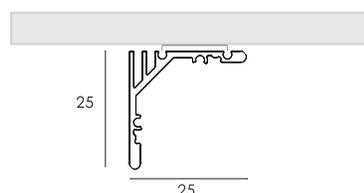

CODICE / CODE	L.MM	COLORE/ COLOR	PREZZO / PRICE
003.028.2000.05	2000	anodizzato / anodised	€25,30
003.028.2000.02	2000	bianco / white	€32,90
003.028.3000.05	3000	anodizzato / anodised	€38,00
003.028.3000.02	3000	bianco / white	€48,80

CODICE / CODE	L.MM	DIFFUSORE / DIFFUSER	PREZZO / PRICE
PIANO/ FLAT			
005.012.2001.22	2000	opalino / opal	€18,70
005.012.3001.22	3000	opalino / opal	€28,20
QUADRO/ SQUARE			
005.028.2001.22	2000	opalino / opal	€16,10
005.028.2001.23	2000	acidato / frosted	€16,10
005.028.3001.22	3000	opalino / opal	€24,00
005.028.3001.23	3000	acidato / frosted	€24,00



## ACCESSORI / ACCESSORIES



**002.028.8012**  
Testata piano.  
Flat end cap.

€ 4,00



**032.024.0001**  
Clip di fissaggio.  
Fixing clip.



**002.028.8011**  
Testata quadra.  
Square end cap.

€ 4,00

€ 0,50

---

DRIVERS

**DRIVERS**

---



## TENSIONE COSTANTE CONSTANT VOLTAGE

CE | IP20 | 



**30W**

- Pri: 220-240V~50/60Hz
- Sec: 24VDC, 2.90A 70W
- Temperatura di utilizzo / Operating Temp: -40°~+45°C

**AAA.TRSL08**    30W/24VDC    € 40,10

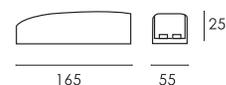

CE | IP20 | 



**75W**

- Pri: 220-240V~50/60Hz
- Sec: 24VDC, 3.12A 75W
- Temperatura di utilizzo / Operating Temp: -40°~+45°C

**AAA.TRSL09**    75W/24VDC    € 68,80

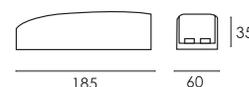

CE | IP20 | 



**8W 75W**

- Pri: 220-240V~50/60Hz
- Sec: 24VDC, 8W
- Temperatura di utilizzo / Operating Temp: -25°~+60°C

**AAA.TRSL14**    8W/24VDC    € 20,70

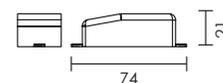

# DRIVERS

# DRIVERS

CE | IP66 | 



10W

- Pri: 220-240V~50/60Hz
- Sec: 24V, 0.8A
- Temperatura di utilizzo / Operating Temp: -10°~+50°C

**AAA.TRSL15**    10W/24VDC    € 43,60

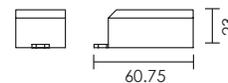

CE | IP67 | 



70W

- Pri: 220-240V~50/60Hz
- Sec: 24VDC, 2.90A 70W
- Temperatura di utilizzo / Operating Temp: -40°~+45°C

**AAA.TRSL13**    70W/24VDC    € 151,50

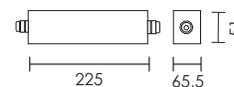

CE | IP67 | 



150W

- Pri: 220-240V~50/60Hz
- Sec: 24VDC, 12.5A 75W
- Temperatura di utilizzo / Operating Temp: -10°~+60°C

**AAA.TRSL16**    150W/24VDC    € 151,50

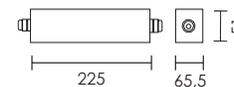

## CORRENTE COSTANTE CONSTANT CURRENT

CE | IP20 | 



### 3W

350mA

- Pri: 220-240V~50/60Hz 0.08A
- Sec:350mA, 2.5 - 10.5V
- Temp. di utilizzo /  
Operating Temp: -5°~+50°C

**AAA.TRSL00** 3W/350mA

**AAA.TRSL30** 3W/700mA

700mA

- Pri: 220-240V~50/60Hz 0.08A
- Sec:700mA, 2.8 - 10.5V
- Temp. di utilizzo /  
Operating Temp: -5°~+50°C

€ 27,30

€ 27,30



CE | IP20 | 



### 6W

- Pri: 220-240V~50/60Hz 0.09A
- Sec:500mA, 2 - 17V
- Temp. di utilizzo / Operating Temp: -20°~+50°C

**AAA.TRSL41** 6W/500mA

€ 31,20



CE | IP20 | 



### 20W

350mA

- Pri: 220-240V~50/60Hz 0.14A
- Sec:350mA, 2 - 58V
- Temp. di utilizzo /  
Operating Temp: -20°~+50°C

**AAA.TRSL05** 19W 350/700mA

**AAA.TRSL45** 20W/500mA

700mA

- Pri: 220-240V~50/60Hz 0.14A
- Sec:700mA, 2 - 29V
- Temp. di utilizzo /  
Operating Temp: -5°~+50°C

€ 37,40

€ 37,40



# DRIVERS

## Condizioni generali di vendita / General sales condition

### 1. TERMINI DI CONSEGNA

La merce viaggia sempre a rischio e pericolo del committente. Gli ordini verranno evasi in base alle disponibilità e le spedizioni potranno essere fatte anche parzialmente. La merce viene sempre resa franco nostro stabilimento. Nel caso in cui dovessero verificarsi mancanze, manomissioni oppure danneggiamenti della merce, l'acquirente dovrà apporre riserve scritte al trasportatore all'atto della ricezione della merce al fine di avere diritto alla riparazione o reintegrazione. Se tali riserve non venissero apposte al trasportatore, l'acquirente perderà automaticamente il diritto alla reintegrazione o riparazione dei prodotti.

Qualsiasi esportazione delle merci acquistate deve essere precedentemente autorizzata dalla CIVIC.

### 2. RESO DI MERCE

I resi di merce potranno essere accettati soltanto previo accordo scritto formale tra la nostra società e l'acquirente.

Tuttavia, tutti quei prodotti non presenti sui listini e cataloghi della nostra società ed oggetto di fabbricazioni o ordini particolari non potranno essere resi in ogni caso. Le spese ed i rischi relativi ai resi di merce rimarranno sempre a carico esclusivo dell'acquirente. Solo dopo una verifica da parte nostra del materiale reso, la nostra società potrà dar luogo ad una nota di credito a favore dell'acquirente o eventualmente alla sostituzione. Rimane inteso che qualsiasi indennità o risarcimento danni a favore dell'acquirente rimarrà esclusa.

### 3. PAGAMENTI

Si riconoscono solamente i pagamenti fatti direttamente al nostro domicilio o a persone autorizzate, da noi, per iscritto. In caso di ritardato pagamento, totale o parziale, verranno addebitati i relativi interessi di mora. Per qualsiasi somma non pagata alla scadenza riportata sulla fattura, si prevede l'applicazione d'interessi moratori pari al tasso BCE +7% (D.lgs 231/2002)

### 4. RISERVA DI PROPRIETA'

Per pagamento da effettuarsi in tutto o in parte dopo la consegna i prodotti consegnati restano di proprietà del venditore fino al momento del completo pagamento del prezzo, nella misura permessa dalla legge del paese dove i prodotti si trovano. Il compratore per tanto si impegna a fare quanto necessario per costituire nel suddetto paese una valida riserva di proprietà nella forma più estesa consentita, o porre in essere un'analoga forma di garanzia a favore del venditore.

### 5. LIMITI DI RESPONSABILITA'

I disegni, le quote, i materiali e i colori degli articoli del presente catalogo si intendono a titolo indicativo.

Al venditore è riservata la facoltà di modificare o perfezionare i prodotti senza obbligo di preavviso o di comunicazione, in base alle proprie esigenze. Le caratteristiche dei prodotti non sono quindi da considerarsi impegnative. Di conseguenza in nessun caso il venditore potrà essere ritenuto responsabile per danni diretti, indiretti o consequenziali, perdite di produzioni o mancati profitti derivanti da modifiche tecniche ai prodotti. Eventuali esportazioni devono essere autorizzate dalla Civic.

### 6. FORO COMPETENTE

Per qualsiasi controversia viene riconosciuta la competenza esclusivamente del foro del venditore.

### 1. DELIVERY TERMS

All goods travel at the Purchaser's own risk. Goods will be delivered in relation to availability and partial orders will also be dispatched. Goods are always delivered ex-factory.

On receipt of the goods, any losses, damages or tampering, the purchaser must immediately advise the Carrier concerned in order to obtain the right for the repairing or re-instatement of order. The Purchaser will automatically lose any right to the repairing or re-instatement of their order if this written notice is not submitted to the Carrier.

Any export of the purchased goods must be previously authorised by Civic.

### 2. GOODS RETURNED

Goods can only be returned if previously agreed between the parties.

In any case, all the products not included in our price list and catalogue and produced especially for the purchaser, will not be returned. All returns are at risk and cost of the Purchaser.

Goods returned will firstly be evaluated before a credit note in favour of the Purchaser will be passed or substitution of the goods.

In any case the purchaser shall not be entitled to any indemnity or reimbursement of damages.

### 3. PAYMENTS

Only payments made directly to our domicile or to persons authorized by ourselves in writing will be accepted.

Any delays in payment or partial payments, could result in default interest being charged to the Purchaser.

Any amounts outstanding on invoice expiry date, the seller has the right to charge interest at the rate indicated from BCE + 7% (according with D.lgs 231/2002).

### 4. TITLE RESERVATION

All goods delivered remain the property of the Seller until all payments have been made in full, within the limits of the law of the country where the products are located.

Consequently the purchaser will have to do all he can in order to constitute, in the country where the products are located, a property reservation in the most extensive form permitted or to create a similar form of guarantee in favour of the seller.

Drawings, sizes, materials and colours of the product contained in this catalogue are purely indicative.

### 5. MANUFACTURER'S RESPONSIBILITY

The seller will have the right to modify or to improve its products without being obliged to previously advise or inform the other party, in relation with its needs. Technical specifications of products are not binding. Consequently under no circumstances can the Seller be considered responsible for direct, indirect or consequential damages, loss of production or lack of profit.

Any exportation must be authorized from Civic.

### 6. COMPETENT JURISDICTION

The seller's court will be competent for any controversy.

## Garanzia / warranty

L'attenzione alla qualità, alla sicurezza e alla durata nel tempo sono tra gli obiettivi fondamentali di CIVIC.  
I prodotti sono garantiti per 2 anni (su richiesta per 5 anni), a condizione che siano installati, mantenuti e utilizzati secondo le istruzioni e quanto comunicato nel catalogo o sul nostro sito web.

Sono esclusi dalla garanzia i materiali di consumo come le sorgenti luminose, i driver ed i LED che rispondono alle norme di garanzia espresse dalla Direttiva Europea in materia.

The attention to quality, safety and durability are some of the fundamental objectives of CIVIC.  
The products are guaranteed for 2 years (5 years on demand), if the lighting fittings have been installed, maintained and used according to the instructions and as communicated in the catalogue or on our web site.

The warranty excludes consumables goods such as light sources, drivers and LEDs that comply with the warranty standards expressed by the European Directive on the subject.

Civic S.r.l. si riserva il diritto di apportare modifiche ai prodotti contenuti all'interno del catalogo in qualsiasi momento.  
Le specifiche come colori e disegni tecnici sono puramente indicativi.

Civic S.r.l. reserves the right to make any changes to the products contained in the catalogue at any moment.  
Specifications such as colours and technical drawings are purely indicative.



Poles

Artisan

Outdoor



Spotlight

LIGHTING

Led

Lamp

Design

Tappeleight

Worldwide



@CIVICLIGHTING



@CIVICLIGHTING



@CIVIC S.R.L.



WWW.CIVIC.IT

**Art Direction**

Danae Almeida  
Lorenzo Esposito  
Tina Ferrari  
Marco Peroni

**Printed** March 2023