

# DONNA



La famiglia Donna comprende proiettori LED orientabili 48V e apparecchi a binario lineari adattabili al sistema MULTITRACK 48V.

Ottimi per la loro versatilità e alte prestazioni, sono ideali in contesti espositivi e museali, così come in ambienti domestici e per il retail.

The DONNA family includes 48V adjustable LED projectors and linear track luminaires suitable to MULTITRACK 48V system. Excellent for their versatility and high performance, they are ideal in exhibition, museum as well as domestic and retail contexts.

Abbinalo ai **binari 48V**  
Match with **48V tracks**

pag. 220



Small  
Large  
Infinity





## Donna 48V **SMALL**

Corpo e anello in lega di alluminio verniciato a polvere. Sorgente luminosa a LED chip on board, CRI 90 o superiore, tono luce bianco 4000K o 3000K. Potenze da 9W a 14W. Alimentatore elettronico incluso nell'adattatore da binario. Disponibile in versione ON-OFF o DALI/PUSH.

Body and ring in powder coated aluminum alloy. LED light source chip on board CRI 90 or superior, 4000K or 3000K White tone. Powers from 9W to 14W. Driver included in the 48V track adapter. Available in ON-OFF or DALI/PUSH version.



## Donna 48V **LARGE**



## Donna 48V **INFINITY**

Corpo in lega di alluminio, testate in acciaio, verniciatura a polveri. Diffusore in policarbonato opale o microprismato UGR per il controllo dell'abbagliamento. Tono luce bianco 4000K o 3000K, Potenze da 6W/286mm a 24W/1128mm. Alimentatore elettronico incluso nell'adattatore da binario. Disponibile in versione ON-OFF o DALI/PUSH.

Body in extruded aluminum alloy, end cap in steel, powder coated. Opal or microprismatic diffuser for UGR glare control. LED in 4000K or 3000K white tone, Powers from 6W/286mm up to 24W/1128mm. Driver included in the 48V track adapter. Available in ON-OFF or DALI/PUSH version.

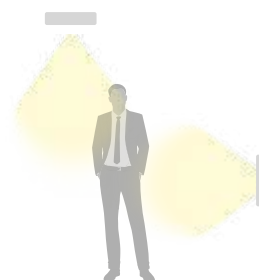

CE	IP20
LED	RG1
CRI 90	48 V
L80 B10	70° 360°
50000H	Corrente Continua
	Direct current



# DONNA 48 V SMALL

COLOR

nero ragg. / rough black - 33

D.  
OPTIC  
20°  
1

OPTIC  
30°  
2

CRI90  
6

Y.  
4000K  
7

3000K  
8

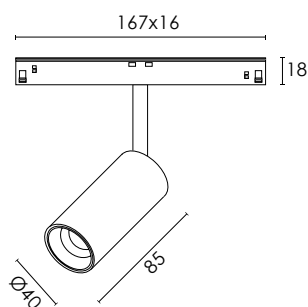

CODICE / CODE	D.MM	W	LM	FASCIO / BEAM	DRIVER
MVI.3703.D 6 Y.33	40	9W/48V	970/950	20°/30°	ON/OFF
MVI.3713.D 6 Y.33	40	9W/48V	970/950	20°/30°	dimmerabile 1-10V



CE	IP20
LED	RG1
CRI 90	48 V
L80 B10	70° 360°
50000H	Corrente Continua
	Direct current

■ 33 - nero ragg. / rough black

COLOR

# DONNA 48 V LARGE

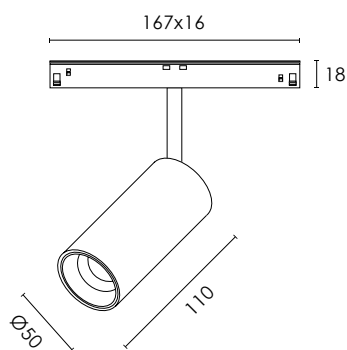

D.  
OPTIC  
12°  
1

OPTIC  
24°  
2

OPTIC  
36°  
3

CRI90  
6

Y.  
4000K  
7

3000K  
8

CODICE / CODE	D.MM	W	LM	FASCIO / BEAM	DRIVER
MVI.3705.D 6 Y.33	50	14W/48V	1370/1350	12°/24°/36°	ON/OFF
MVI.3715.D 6 Y.33	50	14W/48V	1370/1350	12°/24°/36°	dimmerabile 1-10V
MVI.3725.D 6 Y.33	50	14W/48V	1370/1350	12°/24°/36°	dimmerabile DALI

CE	IP20
LED	RG1
CRI 90	48 V
L80 B10	50000H
	Corrente Continua
	Direct current



# DONNA 48 V INFINITY

COLOR

nero ragg. / rough black - 33 ■

D.  
OPAL  
0

MICRO  
PRISMATIC  
9

CRI90  
6

Y.  
4000K  
7

3000K  
8

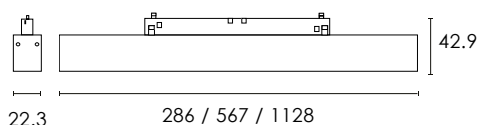

CODICE / CODE	L.MM	W	LM	DRIVER
MVI.6703.D 6 Y. 33	286	6W/48V	810/740	ON/OFF
MVI.6704.D 6 Y. 33	567	12W/48V	1600/1480	ON/OFF
MVI.6724.D 6 Y. 33	567	12W/48V	1600/1480	dimmerabile DALI
MVI.6705.D 6 Y. 33	1128	24W/48V	3200/2970	ON/OFF
MVI.6725.D 6 Y. 33	1128	24W/48V	3200/2970	dimmerabile DALI

ABBINALO A / PAIR IT WITH

BINARIO C  
TRACK C

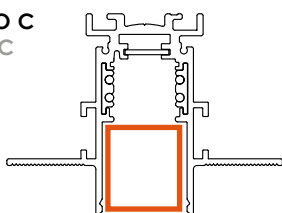

BINARIO D  
TRACK D

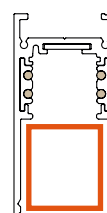





CE	IP20
DALI	Corrente Continua
	Direct current

# BINARI TRACKS 48V

Serie di binari MULTI TRACK 48V. Disponibile in diverse lunghezze per rispondere alle diverse richieste di utilizzo.

48V MULTI TRACKS are available in 3 different lengths for different kind of installations.

COLOR

nero / black - 03

## Scegli il tuo binario Choose your track

Donna  
small  
large



### A. Binario standard 48V. Standard track 48V.

CODICE / CODE	L
<b>MBL.4102.011</b>	L.1m
<b>MBL.4102.012</b>	L.2m
<b>MBL.4102.013</b>	L.3m

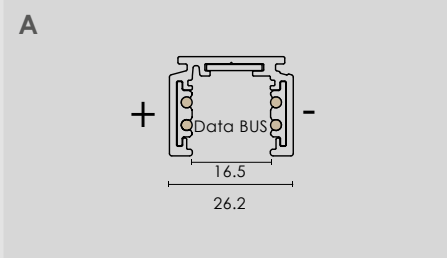

### B. Binario basic 48V. Basic track 48V.

CODICE / CODE	L
<b>MBL.4102.061</b>	L.1m
<b>MBL.4102.062</b>	L.2m
<b>MBL.4102.063</b>	L.3m

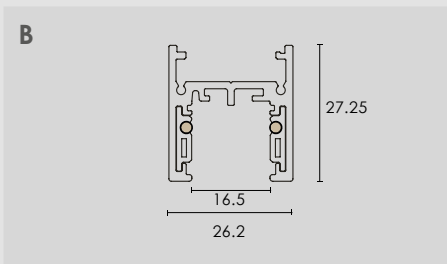

Donna  
Infinity



### C. Binario H 48V. Track H 48V.

CODICE / CODE	L
<b>MBL.4102.021</b>	L.1m
<b>MBL.4102.022</b>	L.2m
<b>MBL.4102.023</b>	L.3m

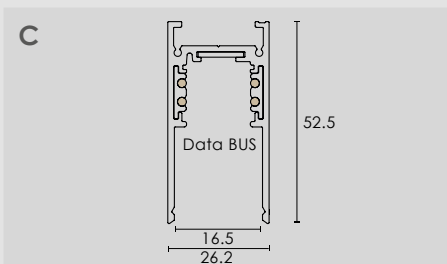

### D. Binario da incasso trimless 48V. Trimless recessed track 48V.

CODICE / CODE	L
<b>MBL.4102.051</b>	L.1m
<b>MBL.4102.052</b>	L.2m
<b>MBL.4102.053</b>	L.3m

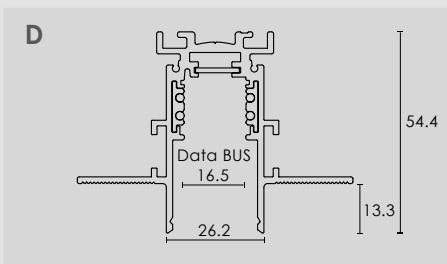

# COMPLETA IL TUO MODULO

## COMPLETE YOUR MODULE

### Tappo di chiusura

#### End cap

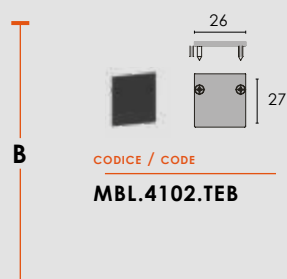
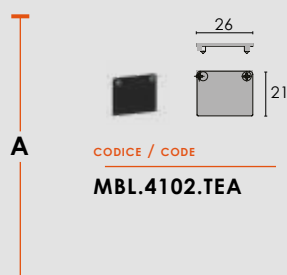

### Kit di sospensione

#### Suspension kit (pair)

COPPIA - PAIR

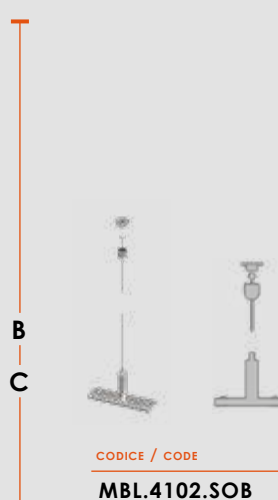

### Alimentazione 48 V

#### Live end 48V



CODICE / CODE  
**MBL.4102.AL**

### Kit Alimentazione per binari 48V

#### Power supply kit for 48V tracks



CODICE / CODE	W
<b>MBL.RA-1</b>	70W ON/OFF
<b>MBL.RA-2</b>	150W ON/OFF
<b>MBL.RA-2-A2</b>	150W DALI

### Giunto passante 48V

#### Linear joint 48V

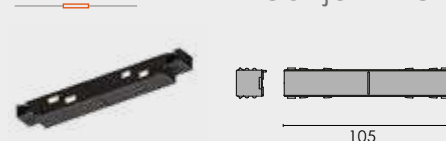

CODICE / CODE  
**MBL.4102.CD**

### Giunto a L 48V

#### L feed 48V

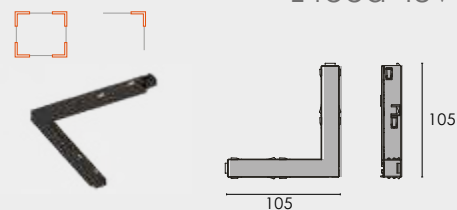

CODICE / CODE  
**MBL.4102.CL**